

Dimplex



OFC1500TI

OFC1000, OFC1500, OFC2000, OFC2500
OFC1000TI, OFC1500TI, OFC2000TI & OFC2500TI

1

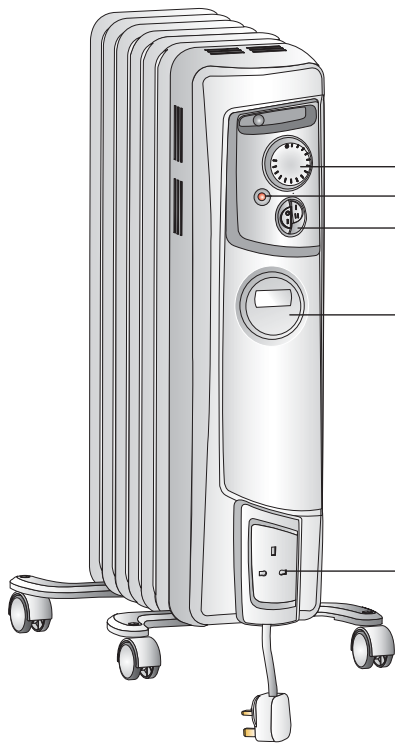

Thermostat
Neon
On/Off
Heat Switches

ALL MODELS

24Hr Timer

OFC1000TI, OFC1500TI,
OFC2000TI & OFC2500TI only

Cable wrap

ALL MODELS

2

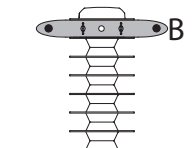
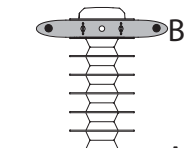
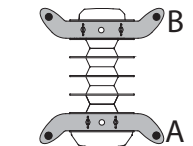
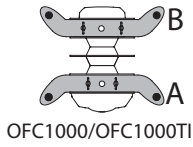
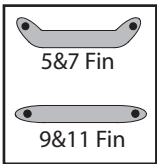

OFC2500/OFC2500TI

3a

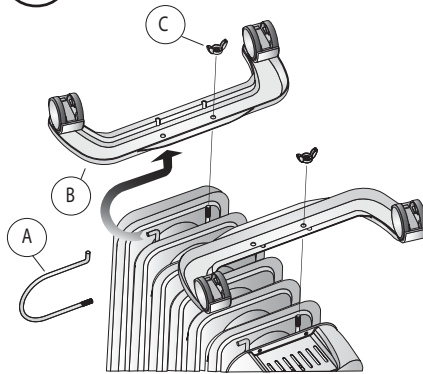

3b

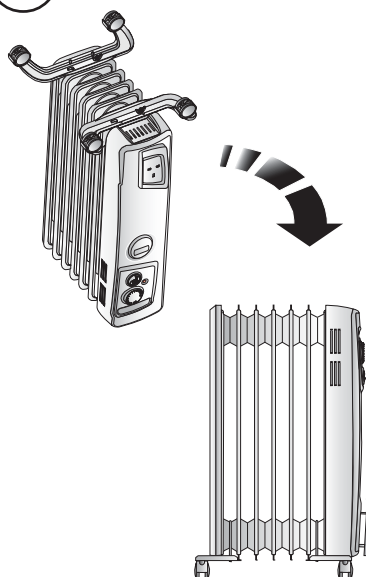

4

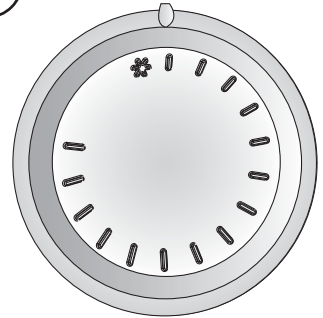

5

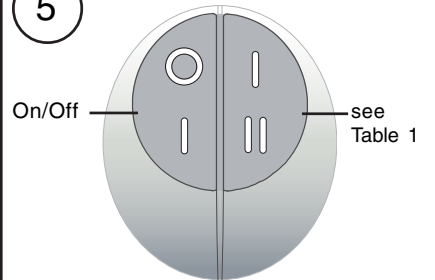

6

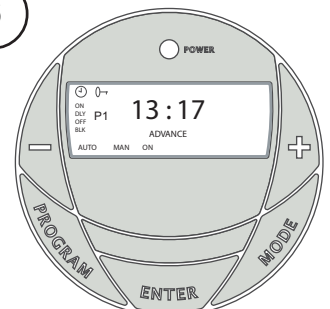

Dimplex Oil filled Column Radiators

Models : OFC1000, OFC1000TI, OFC1500, OFC1500TI, OFC2000, OFC2000TI, OFC2500 & OFC2500TI

THESE INSTRUCTIONS SHOULD BE READ CAREFULLY AND RETAINED FOR FUTURE REFERENCE

Model	Description	Watts
OFC1000	5 Fin, Thermostat, 2 Heat Settings, Neon	1000
OFC1000TI	5 Fin, Thermostat, 2 Heat Settings, Neon, Electronic Timer	1000
OFC1500	7 Fin, Thermostat, 2 Heat Settings, Neon	1500
OFC1500TI	7 Fin, Thermostat, 2 Heat Settings, Neon, Electronic Timer	1500
OFC2000	9 Fin, Thermostat, 2 Heat Settings, Neon	2000
OFC2000TI	9 Fin, Thermostat, 2 Heat Settings, Neon, Electronic Timer	2000
OFC2500	11 Fin, Thermostat, 2 Heat Settings, Neon	2500
OFC2500TI	11 Fin, Thermostat, 2 Heat Settings, Neon, Electronic Timer	2500

Important Safety Advice

If the appliance is damaged, check immediately with the supplier before installation and operation.

Warning – This appliance must not be used in a bathroom.

Warning – Do not use this heater in the immediate surroundings of a bath, a shower or a swimming pool.

Warning – This heater must not be located immediately below a fixed socket outlet.

Warning – Do not use in areas where petrol, paint or flammable liquids are used or stored.

Follow these instructions carefully.

The heater carries a warning 'Do Not Cover' to alert the user to the risk of fire that exists if the heater is accidentally covered.

This appliance is not intended for use by children or other persons without assistance or supervision if their physical, sensory or mental capabilities prevent them from using it safely. Children should be supervised to ensure that they do not play with the appliance.

If the mains lead is damaged, it must be replaced by the manufacturer or its service agent or a similarly qualified person in order to avoid a hazard.

Unplug the heater when not required for long periods.

Do not use the heater if it develops a leak. Unplug the heater and contact your supplier or the manufacturer's service agent.

Momentary contact with any part of the heater should not cause injury. However aged, infirm persons or young children should not be left unsupervised in the vicinity of the heater.

Please Note – We recommend that you open a window to ventilate the room when using the heater for the first time.



THE HEATER CARRIES THE WARNING SYMBOL INDICATING THAT IT MUST NOT BE COVERED.

General

The radiator is designed for operation on an AC electricity supply, and is suitable for use in domestic dwellings and similar indoor locations.

Always ensure that the appliance is stood on a firm, level base near to, but not directly beneath, a suitable fixed socket outlet.

The radiator is fitted with castors and a handle for ease of movement. Selector switches provide a choice of heat output and an adjustable thermostat enables the room temperature to be controlled accordingly. It is supplied with a cord and plug ready for use.

The supply cord should be uncoiled before use (see 'Storage').

DO NOT pull the radiator along by the mains lead.

Important - The radiator must only be operated with the wheels and castors fitted and in the upright position as shown in Fig.1 and Fig.3B.

Warning – The heater complies with stringent safety standards but to ensure efficient operation **SURFACES OF THE HEATER WILL BECOME HOT AND CONTACT WITH THESE AREAS SHOULD BE AVOIDED**, particularly between the fins on the top and sides.

The control panel area is designed to be at a far lower temperature to allow the safe operation of the controls at any time.

Electrical

WARNING – THIS APPLIANCE MUST BE EARTHED

If the socket outlets in your home are not of the 13 amp BS1363 type they will not accept the plug connected to this heater, therefore cut off the plug. When cut off this plug can constitute a shock hazard if inserted into a socket outlet. It must therefore be disposed of safely.

Before wiring the appropriate plug please note that the wires in this

mains lead are coloured in accordance with the following code:

GREEN/YELLOW : EARTH
BLUE : NEUTRAL
BROWN : LIVE

Connect the Green/Yellow wire to the terminal marked E or the earth symbol or coloured Green or Green/Yellow.

Connect the Brown wire to the terminal marked L or coloured Red.

Connect the Blue wire to the terminal marked N or coloured Black. **DO NOT** connect the Brown (Live) or the Blue (Neutral) wires to the Earth terminal of your 13 amp plug. If the terminals of the plug are unmarked or you are in any doubt, consult a qualified electrician.

Fitting the castors

The castors can only be fitted between the outer fins (as shown in Fig. 2). Turn the radiator upside down on a carpet or other soft surface to avoid damage

WARNING : THE RADIATOR IS HEAVY – ENSURE THAT IT IS SUPPORTED TO PREVENT IT FROM TOPPLING. Ask a second person to help with this if necessary. Locate the wire clamps and remove the winged nuts (see 'C') in Fig.3A. Insert the non threaded end of the wire clamp 'A' into one of the holes in the castor plate 'B' as shown in Fig.3A, at the same time tilting the opposite end of the plate slightly. Lower the castor plate and insert the threaded end of the clamp through the fins and over the boss and into the other hole in the castor plate. Place the winged nut 'C' on the thread and tighten it securely.

Repeat the process for the other castor bracket onto the last fin.

Note: The 9 and 11 fin column radiator models - use straight castor brackets and must be fitted as shown in Fig.2.

Lift the radiator clear of the floor, then turn it back upright and stand it on its castors as shown in Fig.1 and Fig.3B. It is now ready for use.

Positioning the Heater

Select the position for the radiator ensuring there is clearance from any furniture and fittings of at least 300mm above the heater and 150mm each side. The radiator should only be operated on a flat stable surface.

Operation

IMPORTANT – Objects or clothing must not be placed on this heater. Before using the heater ensure that all warnings and instructions have been read carefully.

To bring the heater into use plug it in. Neon indicating lights located at the controls area will glow when the appliance is plugged into the mains.

Controls

Thermostat (see Fig.4)

The Thermostat (see Fig.4) controls the heat output according to the room temperature. This ensures that the heater will not produce heat unnecessarily when the room is warm. To set the temperature you require, turn the thermostat knob clockwise until the required setting is reached. Alternatively to heat a cold room quickly, turn the thermostat knob up fully. When the room has reached the desired temperature, turn the thermostat knob anti-clockwise until the thermostat just clicks off. The heater will now automatically operate at this temperature. The thermostat also has a frost protection setting marked '❄️'. This setting is useful in areas such as garages, to prevent frost damage. If the thermostat is set to its minimum setting '❄️', the heater will cycle on and off to maintain a temperature of approximately 5° to help protect against frost.

Note – Should the heater fail to come on when the thermostat is at a low setting, this may be due to the room temperature being higher than the thermostat setting.

Heat Selector Switches (see Fig.5)

Selector switches located on the control panel provide a choice of heat output to suit varying conditions and for economy of operation.

Table 1

Model	Switch I	Switch II
OFC1000/OFC1000TI	600W	1000W
OFC1500/OFC1500TI	800W	1500W
OFC2000/OFC2000TI	1100W	2000W
OFC2500/OFC2500TI	1250W	2500W

Digital Timer Operation (see Fig. 6)

IMPORTANT: Remember to observe all safety warnings when operating the heater on auto setting, either attended or unattended.

The timer allows you to select 'AUTO' or 'MAN ON' by pressing the 'MODE' button until the required MODE appears at the bottom of the timer display.

'AUTO' MODE allows the heater to switch ON and OFF according to a set 24 Hour program period (see 'Setting Programs' section below).

'MAN ON' MODE allows power to the heater uninterrupted by the program settings.

Key Lock:

If 'ENTER' and 'MODE' are pressed within 1 second, the keys will be locked. The user will know the keys are locked as the lock symbol '🔒' will be displayed on the top left hand corner of the screen. To unlock the keypad, press 'ENTER' and then 'MODE' within 1 second.

Initial Operation

For initial use, plug the heater into a regular household power point and turn the power on. The timer is now ready to be set up for use.

Setting Current Time

1. Press the 'PROGRAM' button ONCE. The clock symbol ⌚ appears on the top left hand side of the screen. The user can now set the clock.
2. The hour digit will flash. To adjust the hour use the '-' & '+' buttons. Confirm the hour digit by pressing 'ENTER'.
3. Once 'ENTER' has been pressed the minutes will flash. To adjust the minutes use the '-' & '+' buttons. Confirm the minute digit by pressing 'ENTER'.
4. The timer now returns to the default display.
5. To reset incorrect time, repeat previous steps.

Once the correct time is set, a total of four ON/OFF time programs can be set for operation.

Setting Programmes

Press the 'PROGRAM' key twice to set the programs. You are now setting the programs starting with P1 'ON'.

SETTING P1 ON TIME:

1. To set the hour use the '-' & '+' buttons. Confirm the hour digit by pressing 'ENTER'.
2. To set the minutes use the '-' & '+' buttons. Confirm the minute digit by pressing 'ENTER'.

Note: The minutes can only be set in 10 minute blocks in programme 'MODE'.

SETTING P1 OFF TIME:

3. To set the hour use the '-' & '+' buttons. Confirm the hour digit by pressing 'ENTER'.
4. To set the minutes use the '-' & '+' buttons. Confirm the minute digit by pressing 'ENTER'.

Repeat steps 1 to 4 to programme P2, P3 & P4. After programming P4 'OFF' you automatically exit to the default display.

At any time while programming the timer you can press the 'PROGRAM' button to exit to the default display.

Note: If the 'ON' time is the same as the 'OFF' time the appliance will ignore the program.

The Advance Function

When in 'AUTO' MODE, if the '+' button is pressed for longer than 2 seconds the programme will ADVANCE to the next setting programmed and will only revert back to the program when the subsequent programme time is reached. When the 'ADVANCE' function is running the 'ADVANCE' segment will be displayed on the LCD screen. If the '-' button is pressed when the 'ADVANCE' programme is running the 'ADVANCE' feature will be automatically cancelled and the programme will run as normal.

Note - Timer Memory Back Up Batteries - Once the heater has been left plugged in with the socket switched on for at least 72 hours the timer's memory back up batteries will be fully charged.

Once the timer batteries are fully charged, if there is a power cut or if the heater is disconnected from the mains for less than six months, then the timer will continue to keep time & the settings in the memory will remain intact. If however the timer back up batteries have not been charged fully, or if the heater is deprived of power for longer than six months, then the time and the programme settings are likely to be lost and you may

therefore need to reset the time and the programme before using the AUTO MODE again.

Safety in use

This appliance incorporates a number of safety devices. In addition to the 'Important Safety Advice' section your attention is drawn to the following:

Tilt Switch

The tilt switch will prevent the heater from working if it is accidentally tipped over on its side.

If the radiator is tipped over while it is hot, disconnect the power and allow it to cool, then stand the radiator back upright. Reconnect the power - normal operation should be resumed.

Safety Overheat Protection

The heater is fitted with a thermal safety cut-out which will switch off the heater should it overheat for any reason. If the cut-out operates it is the result of abnormal overheating, and customer services should be contacted for further advice - see 'After Sales Service'.

Storage

If the radiator is not required for long periods, for example during the summer, it should be stored in a dry place and preferably covered to prevent the accumulation of dirt and dust. The supply cord should be neatly coiled around the cable wrap (see Fig. 1) and the plug should be inserted in to the plug pin holes provided in the cable wrap.

IMPORTANT

The heater must be kept plugged in at the mains to retain the time and the programmed settings. If unplugged from the mains, resetting the time and the programmed settings will be necessary.

Cleaning

WARNING - ALWAYS DISCONNECT THE POWER SUPPLY BEFORE CLEANING THE HEATER.

Do not use detergents, abrasive cleaning powder or polish of any kind on the body of the heater.

Allow the heater to cool, then wipe with a dry cloth to remove dust and a damp cloth (not wet) to clean off stains. Be careful not to allow moisture in to the heater.

Recycling



For electrical products sold within the European Community. At the end of the electrical products useful life it should not be disposed of with household waste. Please recycle where facilities exist. Check with your Local Authority or retailer for recycling advice in your country.

After Sales Service

Your product is guaranteed for three years from the date of purchase.

Within this period, we undertake to repair or exchange this product free of charge provided it has been installed and operated in accordance with these instructions.

Your rights under this guarantee are additional to your statutory rights, which in turn are not affected by this guarantee.

Should you require after sales information or assistance with this product please go to www.dimplex.co.uk where you will find our self help guide by clicking on "After Sales" or ring our help desk on 0845 600 5111 (UK) or 01 842 4833 (R.O.I.).

Spare parts are also available on the website www.dimplex.co.uk.

The fins of this heater is filled with a precise quantity of special oil. Repairs requiring opening of the oil container are only to be made by the manufacturer or its service agent. For further advice if an oil leak is suspected please contact our Customer Services Helpline. Regulations concerning the disposal of oil when scrapping the appliance must be followed.

Please retain your receipt as proof of purchase.

Dimplex UK Limited
Millbrook House
Grange Drive
Hedge End
Southampton
Hampshire. SO30 2DF

www.dimplex.co.uk

Republic of Ireland Tel. 01 8424833

[c] Dimplex UK Limited

All rights reserved. Material contained in this publication may not be reproduced in whole or in part, without prior permission in writing of Dimplex UK Limited.