

Dimplex Convector Heaters

Models : 402T, 402TS, 402TSTi, 402TSF & 402TSFTi



08/52558/0 Issue 3

Intertek

Dimensions (Millimetres)

Models Specification

Models	Specification
402T	2.0kw Thermostat,
402TS	2.0kw Thermostat & 2 heat settings,
402TSTi	2.0kw Thermostat, Timer & Neon,
402TSF	2.0kw Thermostat & 2 heat settings, Turbo & Neon,
402TSFTi	2.0kw Thermostat, 2 heat settings, Timer, Turbo & Neon

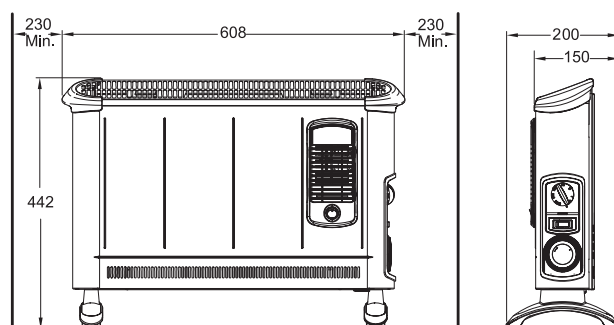

Fig. 1

IMPORTANT : THESE INSTRUCTIONS SHOULD BE READ CAREFULLY AND RETAINED FOR FUTURE REFERENCE
As with all portable heating appliances - This product is only suitable for well insulated spaces or occasional use

Important Safety Advice

WARNING: This appliance must not be used in a bathroom.

WARNING: Do not use this heater in the immediate surroundings of a bath, a shower or a swimming pool.

WARNING: This heater must not be located immediately below a fixed socket outlet.

 The heater carries a warning symbol to alert the user to the risk of fire that exists if the heater is accidentally covered.

WARNING: In order to avoid a hazard due to inadvertent resetting of the thermal cut-out, this appliance must not be supplied through an external switching device, such as a timer, or connected to a circuit that is regularly switched on and off by the utility.

This appliance can be used by children aged from 8 years and above and persons with reduced physical, sensory or mental capabilities or lack of experience or knowledge if they have been given supervision or instruction concerning the use of the appliance in a safe way and understand the hazards involved. Children shall not play with the appliance. Cleaning and user maintenance shall not be made by children without supervision.

Children of less than 3 years should be kept away unless continuously supervised. Children aged from 3 years and less than 8 years shall only switch on/off the appliance provided that it has been placed or installed in its intended normal operating position and they have been given supervision or instruction concerning the use of the appliance in a safe way and understand the hazards involved. Children aged from 3 years and less than 8 years shall not plug in, regulate and clean the appliance or perform user maintenance.

CAUTION: Some parts of this product can become very hot and cause burns. Particular

attention has to be given where children and vulnerable people are present.

WARNING: Do not use the heater in small rooms when they are occupied by persons who are not capable of leaving the room on their own, unless constant supervision is provided.

WARNING: To reduce the risk of fire, keep textiles, curtains or any other flammable material a minimum distance of 1m from the air outlet.

Do not use the heater if it has been dropped. Do not use the heater if there are any visible signs of damage.

If the mains lead is damaged, it must be replaced by the manufacturer or its service agent or a similarly qualified person in order to avoid a hazard.

The heater should only be used on a horizontal and stable surface with the feet securely fitted

Electrical connection

WARNING – THIS APPLIANCE MUST BE EARTHED

The use of an extension lead or multi-plug adaptor is not advised when connecting this product to the mains. Connection through these devices could lead to a risk of overloading, overheating and even fire at the extension lead or adaptor due to inadequate connection quality.

This heater must be used on an ~ supply only and the voltage marked on the heater must correspond to the supply voltage. This heater is fitted with a rewirable plug incorporating a 13 amp fuse. In the event of replacing the fuse in the plug supplied, a 13 amp fuse approved by ASTA to BS 1362 must be used. If any other type of plug is used, a 15 amp fuse must be fitted in the plug, the adaptor, or at the distribution board.

IMPORTANT : If the plug is not suitable for your socket, the 13 amp plug should be removed. Before wiring the appropriate plug, please note that the wires in this mains lead are coloured in accordance with the following code :

GREEN AND YELLOW:	EARTH
BLUE :	NEUTRAL
BROWN :	LIVE

Connect the **GREEN AND YELLOW** wire to the terminal marked 'E' or by the earth symbol , or coloured **GREEN** or **GREEN AND YELLOW**.

Connect the **BROWN** wire to the terminal marked 'L' or coloured **RED**.

Connect the **BLUE** wire to the terminal marked 'N' or coloured **BLACK**.

Using the heater

WARNING: DO NOT USE THE HEATER UNTIL THE FEET ARE FITTED CORRECTLY.

The product is intended for occasional use as a portable unit. Please ensure the feet are securely fitted before the product is used. Once the feet have been installed simply plug in and switch on at the wall socket.

Please note – the element has been coated with a protective film which will burn off during the first few minutes of use and may cause a small amount of fuming. This is quite normal – the fumes are non-toxic and will quickly disappear.

We recommend that you open a window to ventilate the room when using the heater for the first time.

Positioning the heater

Always ensure that the heater is stood on a firm, level base near to, but not directly beneath, a suitable mains supply socket.

Ensure that curtains and furniture are not positioned close to the chosen position, as this would create a potential fire hazard.

Product Assembly

WARNING: THE HEATER SHOULD NEVER BE USED WITHOUT THE FEET SECURELY FITTED.

Lay the heater on its back so the underneath of the product is accessible. Locate and remove the foot fixing screw - see **Fig. 2(a)**. Clip the foot in place and secure using the foot fixing screw - see **Fig. 2(b)**.

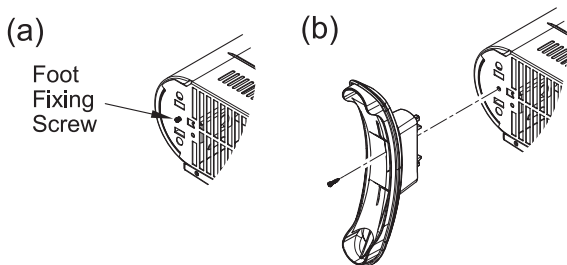

Fig. 2

Controls

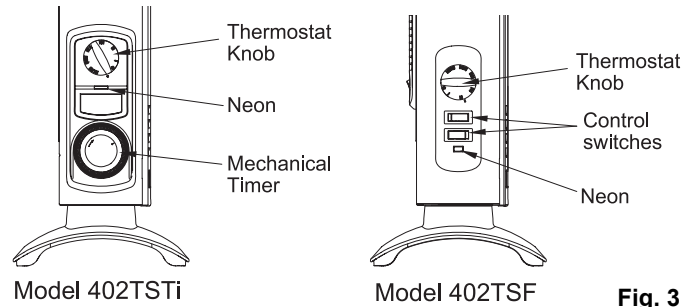

Fig. 3

Indicator Neon (selected models)

The indicator neon comes on when the appliance is connected to mains supply.

Thermostat (all models)

The thermostat controls the heat output according to the room temperature. This ensures that the heater will not produce heat unnecessarily when the room is warm.

To set the temperature you require, Gradually turn the thermostat knob clockwise until the desired temperature is reached. Allow some time between increments for the room temperature to stabilise.

Alternatively to heat a cold room quickly, turn the thermostat knob to the Max position. When the room has reached the desired temperature, turn the thermostat knob anti-clockwise until the thermostat clicks off. The heater will then automatically maintain this room temperature.

The thermostat also has a frost protection setting marked '❄️'. This setting is useful in areas such as garages to prevent frost damage. If the thermostat is set to its minimum setting '❄️', the heater will cycle ON and OFF to maintain a temperature of approximately 5°C to help protect against frosty conditions.

Switches (selected models)

Selected models are supplied with selector switches. There are two switch types, one is an on/off switch and the other is a heat selection switch. Depending on model either one or both switch may be included. The switch operation is as follows.

On/Off:	O	-	Off
	I	-	On
Heat selection	I	-	Low heat
	II	-	High heat

Mechanical Timer (selected models)

Note: The timer clock will only operate when the product is connected to the mains supply

Operation modes

There are two operating modes on the timer, Manual operation and Auto operation. The operation mode is set using the slide switch on the timer - see **fig 4**.

Manual operation (Position - I)

This setting allows power to the product uninterrupted by the timer, however other product controls will continue to function as normal.

Auto operation (Position - ⌚)

This setting allows the heater to be controlled by the timer. The product will be switched on and off depending on the pre-set timer program.

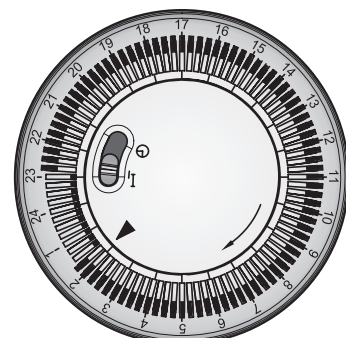

Fig. 4

Setting the time of day

To set the time of day, rotate the timer dial clockwise (indicated by the arrow) until the correct time of day is opposite the reference mark ► - see Fig. 4. The 24-hour clock is used ; e.g. 4 pm is '16' (16:00hrs).

Setting the 'Auto' ON and OFF times

To set the timer :

1. Using your finger tip or the tip of a pencil, push in as many segments as necessary around the dial, according to the times you don't require heat – see Fig. 5. Each segment pushed in switches the heater OFF for that part of the hour. All other segments will be ON. For example, Fig. 5 shows the timer set to switch the heater OFF between 11pm and 1.45am.
2. You can select as many ON periods as you like, within the 24-hour day. The settings will repeat every day until changed.
3. To change ON and OFF times, simply push in any 'ON' segments you wish to cancel and pull out new 'ON' segments as required.

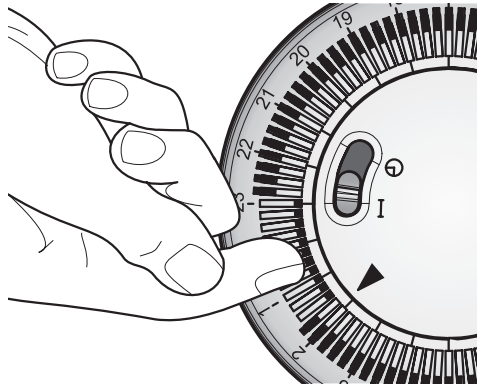



Fig. 5

Switching to auto

Ensure the thermostat and/or the heat selector are set for the desired heat output.

Check that the clock shows the correct time of day. Set the mode slide switch to , the heater will switch ON and OFF according to the timer settings - see Fig. 5.

Note

Remember to observe all safety warnings when operating the heater on auto setting unattended or attended .

If the mains supply to the heater is interrupted, the timer clock will stop until power is restored ; reset the time of day to ensure correct ON and OFF times.

Turbo fan(selected models)

The turbo fan is used to boost the airflow around the room. This circulates the heat better and results in a reduced heat up time and a more even heat distribution. The turbo fan is controlled by the neon switch on the front of the product.

The turbo can be turned on independently of the heat, however the fan will switch on and off under the control of the thermostat.

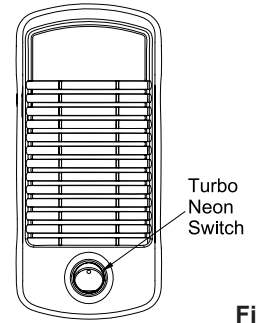

Fig. 6

Note: on selected models in warm weather the fan can be used to circulate cool air. Once the heat selection switches are in the off position and the thermostat is set to 'Max' the fan will continue to function to circulate cool air.

Safety – overheat protection

For your safety, this appliance is fitted with a thermal cut-out. In the event that the product overheats, the cut-out switches the heater off automatically. To bring the heater back into operation, remove the cause of the overheating, then unplug or turn off the electrical supply to the heater for a few minutes. When the heater has cooled sufficiently, re-connect and switch on the heater.

Important Notes

Although this heater is manufactured to comply with the relevant safety standards, certain types of carpets could become discoloured by the temperatures under a portable heater. If you are concerned about this, we recommend that you contact the carpet manufacturer for guidance. Alternatively, either stand the heater on a suitable base to shield the carpet – call our Helpline for further advice.

You may notice some parts of the element appearing to be hotter from time to time because of the variable airflow through the heater. This does not cause a safety hazard.

The heat outlet grille may become discoloured with use – this is caused by airborne pollution and is not a fault.

Recycling



For electrical products sold within the European Community. At the end of the electrical products useful life it should not be disposed of with household waste. Please recycle where facilities exist. Check with your Local Authority or retailer for recycling advice in your country.

Cleaning

WARNING – ALWAYS DISCONNECT FROM THE POWER SUPPLY BEFORE CLEANING THE HEATER.

Before commencing cleaning, switch off the heater and allow it to cool. Disconnect the electricity supply to the appliance.

The outside can be cleaned by wiping it over with a soft damp cloth and then dried. Do not use abrasive cleaning powders or furniture polish, as this can damage the surface finish.

After Sales Service and Guarantee terms and conditions

Your product is guaranteed for 3 years from the date of purchase. If you experience a problem with our Dimplex product, which is found to be defective due to faulty materials or workmanship within the Guarantee Period, this Dimplex Guarantee will cover repair or - at the discretion of Dimplex- replacement with a functionally equivalent Dimplex product.

Within the guarantee period we undertake to repair or exchange this product free of charge providing:

- Proof of purchase such as a sales receipt should be provided, showing that the appliance was bought within the 36-months prior to registering the defect/fault.
- The appliance was correctly installed and operated in accordance with the manufacturer's instructions and used solely for domestic purposes.
- The defect/fault was not as a result of accident, misuse, unauthorised modification or inexpert repair

Your rights under this guarantee are additional to your statutory rights, which in turn are not affected by this guarantee.

If after following these steps your product still does not operate you should return it to your point of purchase. Please do not return a faulty product to us as this may result in loss or damage and delay in providing you with a satisfactory service.

Please retain your receipt as proof of purchase.

What is not covered by a Dimplex Guarantee?

The Dimplex Guarantee does not cover any of the following:

Any fault or damage to your Dimplex product due to faulty materials or workmanship occurring outside the [three year] Guarantee Period.

Normal wear and tear including parts that might wear out over time or consumables, such as [filters].

Any fault or damage occurring to any pre-owned Dimplex product or to any other equipment or property.

Accidental damage to your Dimplex product or damage to your Dimplex product from external sources (for example, transit, weather, electrical outages or power surges).

Fault or damage to your Dimplex product which is:

- not due to faulty materials or workmanship or which is due to circumstances outside Dimplex's control.
- caused by use of your Dimplex product for anything other than normal domestic household purposes in the country where it was purchased.
- caused by any misuse, abuse or negligent use of the Dimplex product, including but not limited to any failure to use it in accordance with the Operating Instructions supplied with the product.
- caused by any failure to assemble, install clean and maintain your Dimplex product in accordance with the Operating Instructions supplied with the product unless this was carried out by Dimplex or its authorised dealers.
- caused by repairs or alterations to your Dimplex product not carried out by Dimplex service personnel or its authorised dealer(s).

Terms and Conditions

The Dimplex Guarantee is valid for three calendar years from the date of purchase of your Dimplex product from a recognised retailer in the country of purchase and use, or the date of delivery of the product if later, always provided the original receipt has been retained and is produced as proof of purchase.

You must provide to Dimplex or its authorised agents on request the original receipt as proof of purchase and - if required by Dimplex - proof of delivery. If you are unable to provide this documentation, you will be required to pay for any repair work required.

Any repair work under the Dimplex Guarantee will be carried out by Dimplex or its authorised dealer(s) and any parts that are replaced will become the property of Dimplex. Any repairs performed under the Dimplex Guarantee will not extend the Guarantee Period.

Any replacement of your Dimplex product by Dimplex during the Guarantee Period will start the three-year Guarantee Period afresh from the date of delivery of the replacement Dimplex product to you.

The Dimplex Guarantee does not entitle you to recovery of any indirect or consequential loss or damage including but not limited to loss or damage to any other property.

The Dimplex Guarantee is in addition to your statutory rights as a consumer and your statutory rights are not affected by this Dimplex Guarantee.

Contact Dimplex

If you have any questions about what the Dimplex Guarantee covers and does not cover or how to claim under the Dimplex Guarantee, please contact us:

GDC Group LTD, Millbrook House, Grange Drive, Hedge End, Southampton SO30 2DF

Telephone: 0844 879 3588

Email: customer.services@gdcgroup.co.uk

Visit: www.gdcgroup.co.uk

Model Identifier(s):		402T	402TS	402TSTi	402TSF	402TSFTi	
Heat output							
Nominal heat output	P _{nom}	2.0	2.0	2.0	2.0	2.0	kW
Minimum heat output (indicative)	P _{min}	2.0	1.2	2.0	1.2	1.2	kW
Maximum continuous heat output	P _{max,c}	2.0	2.0	2.0	2.0	2.0	kW
Auxiliary electricity Consumption							
At nominal heat output	e _{lmax}	0.0	0.0	0.0	0.0	0.0	kW
At minimum heat output	e _{lmin}	0.0	0.0	0.0	0.0	0.0	kW
In standby mode	e _{lSB}	0.0	0.0	0.0	0.0	0.0	kW
Type of heat output/ room temperature control							
With mechanical thermostat room temperature control							Yes
Contact details	GDHV, Millbrook House, Grange Drive, Hedge End, Southampton, SO30 2DF						



The product complies with the European Safety Standards EN60335:2-30 and the European Standard Electromagnetic Compatibility (EMC) EN55014:1, EN55014:2, EN61000:3-2 and EN61000:3-3 which cover the essential requirements of EMC Directive 2014/30/EU and the LVD Directive 2014/35/EU.