

MODEL DTW16S (220-240 VAC)

SUMMARY

◆ OPTIONS SELECTION

At the back of the thermostat, there are two selection switches to set your preferences.

⇒ Temperature in °C or °F and the Early Start function.

◆ TO SET TIME AND DAY

Press on DAY, HOUR and MIN buttons to adjust time and day.

◆ TO RECORD THE ☀ (COMFORT) SETPOINT TEMPERATURE

Select chosen setpoint temperature by using ▲ or ▼ button. Press on ☀ button (2 to 3 seconds) until ☀ icon appears on display.

◆ TO RECORD THE ☾ (ECONOMY) SETPOINT TEMPERATURE

Select chosen setpoint temperature by using ▲ or ▼ button. Press on ☾ button (2 to 3 seconds) until ☾ icon appears on display.

◆ TO RECORD THE 🏠 (VACATION) SETPOINT TEMPERATURE

Select chosen setpoint temperature by using ▲ or ▼ button. Press on 🏠 button (2 or 3 seconds) until 🏠 icon appears on display.

◆ OPERATING MODES

To select an operating mode or to exit the programming mode, use Mode/Return button.

AUTO: Runs the programs. ▲ or ▼ shows temperature setting and can temporarily override your programming up to the next program.

MAN: Maintains the selected temperature. ▲ or ▼ changes the temperature setting.

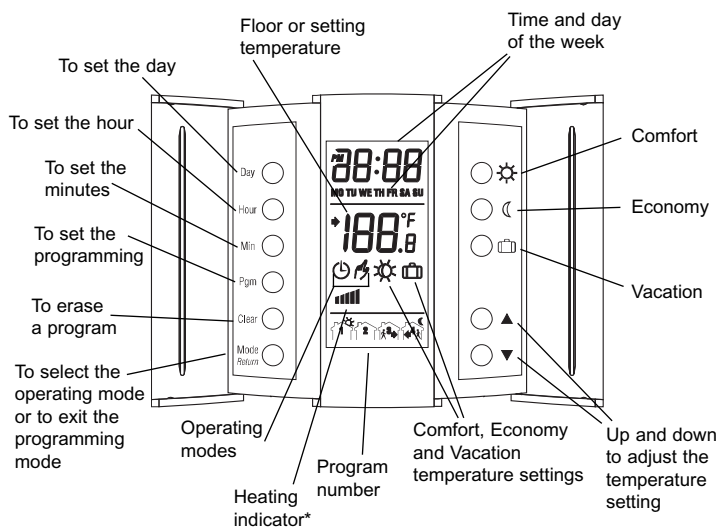

* Percentage (%) of energy sent to the heating system to maintain the desired temperature.

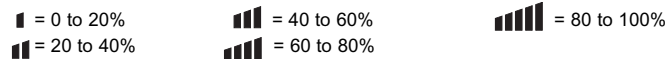

INSTALLATION

This thermostat is designed to control floor heating systems. The resistive load must not exceed 3450 watts (NI) @ 220-240 VAC (15 A). Electricians or experienced technicians should install the thermostat. All work must conform to the most recent IEE Wiring Regulations.

This thermostat should be connected on a circuit equipped with a fuse or a circuit breaker. It must be installed on a certified electrical box.

For a new installation, choose a location about 1.5 m above the floor, with good air circulation. The thermostat must be installed on an inside wall.

Avoid locations where there are air drafts (top of a staircase, air outlet), dead air spots (behind a door), direct sunlight or concealed chimneys or stove pipes.

TURN OFF POWER TO THE HEATING SYSTEM AT THE MAIN POWER PANEL TO AVOID ELECTRICAL SHOCK. Keep air vents of the thermostat clean and free from obstructions.

PARTS INCLUDED

- One (1) DTW16S (220-240 VAC) thermostat
- One (1) temperature sensor with a 3-meter extension
- One (1) cover plate

1. Installation of thermostat

Turn off power to the heating system at the main power panel to avoid electrical shock.

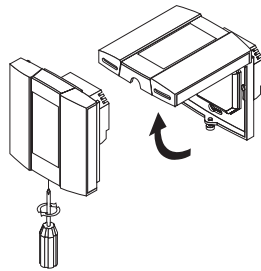

Unscrew and remove the front part of the thermostat from the base.

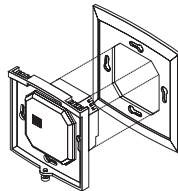

Before making the connections, make sure that the base covers the electrical box entirely. If not, insert the cover plate on rear of the base.*

*The cover plate can be used to cover the plate for aesthetics.

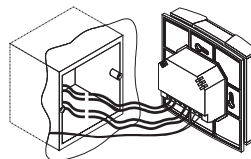

Connect the wires. (see section 1.1)

Connect the floor sensor. (see section 1.2)

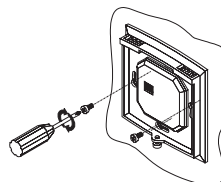

Secure the base to the electrical box anchorage. (The head of the screw must be less than 2mm of thickness)

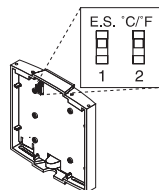

Set the switches located at the back of the front part of the thermostat before replacing it in the base (see section 1.3).

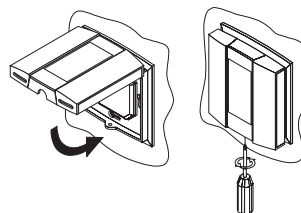

Affix the front part of the thermostat to the base using the enclosed screw. You can now turn the power back on.

1.1 Wire connections

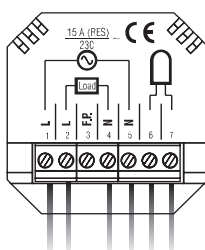

F.P. : Unconnected

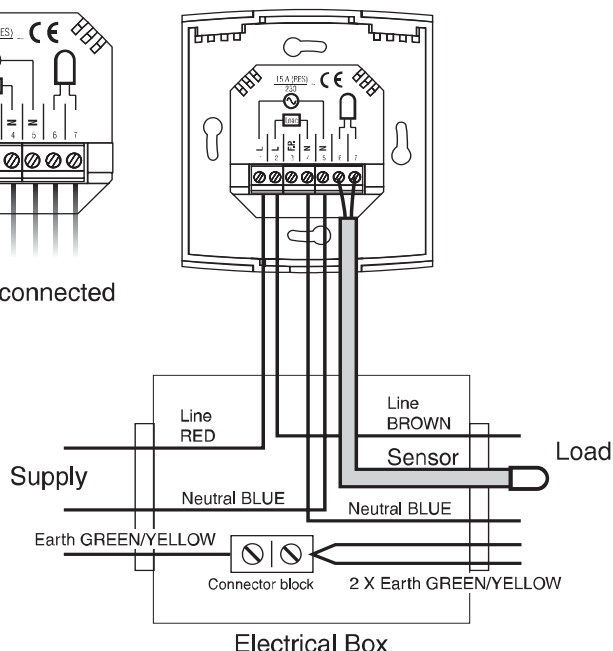

1.2 Connecting the temperature sensor wire

Connect the temperature sensor wires to the sensor terminals located at the back of the thermostat (no polarity needs to be respected).

Note: Do not place the sensor probe directly next to an element. For maximum performances, the sensor probe should be centered between the wires in the mat (80°C max.). The temperature sensor wire cannot lay across any heater wires.

1.3 Configuration of switches

a) Early Start function



The thermostat is providing a built-in function enabling it to calculate the optimum time to start the heating system to achieve the desired temperature setting at the programmed time. To enable this function, set the switch E.S. (#1) to "ON".

b) Temperature in °C or °F



The default configuration of the DTW16S is in °C. If you wish to change the temperature to °F, push the switch #2 upward. Please note that if you change from °C to °F, your Comfort and Economy settings will need to be reconfigured as well.

POWER-UP

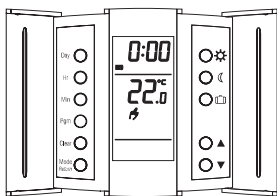

When power is applied for the first time, the display must show the time 0:00, the floor temperature and the Manual mode icon (👉). Other information might show up on the display if the installation is defective, does not comply with the instructions or if it is not the first time that it is being installed.

The message L0 or H1 will appear on the display if the temperature sensor is defective or the temperature is below 0 °C or higher than 60 °C.

OPERATING MODES

The DTW16S has two (2) operating modes:

MANual (👉)

This mode maintains a constant floor temperature.

- To activate this mode, press on Mode/Return button to display the 👉 icon.
- Set the desired temperature using the ▲ ▼ buttons or select the pre-determined ☀️, ☾ or 🏠 settings.

AUTOMATIC (🕒)

This mode executes your scheduled programming.

To activate this mode, press on Mode/Return button to display the 🕒 icon. The ☀️ or ☾ icon indicates which temperature setting is used. The program number icon will also be displayed.

Vacation function

This function sets your thermostat to your specified Vacation temperature.

You can switch to the Vacation setting for a prolonged absence by pressing on the 🏠 button. The display will show the 🏠 icon. The temperature will remain at this setting until it is returned to the normal operating mode by selecting the Mode/Return button. If you wish to immediately return to the programmed settings, press on Mode/Return button.

PROGRAMMING

Programming the time and day

- Set the time using the Hour and Min buttons.
- Set the day using the Day button.

Programming the Comfort, Economy and Vacation settings

The Comfort ☀️, Economy ☾ and Vacation 🏠 settings represent respectively the temperatures that you wish to have during the day ☀️, at night or while you are away at work ☾, or while you are away for an extended period 🏠.

To program your settings :

- To program the Comfort temperature, select the desired temperature using the ▲ ▼ buttons and press the ☀️ button until the ☀️ icon is displayed (app. 3 seconds).
- To program the Economy temperature, select the desired temperature using the ▲ ▼ buttons and press the ☾ button until the ☾ icon is displayed (app. 3 seconds).

- To program the Vacation temperature, select the desired temperature using the ▲ ▼ buttons and press on the 🏠 button until the 🏠 icon is displayed (app. 3 seconds).
- Press the Mode/Return button to exit this function and return to the normal operating mode.

Schedule programming

The DTW16S has 4 programs for each day of the week. The programs are tailored to adapt perfectly to your life style. The principle is very simple. For each day, enter the time at which you wake up (P1), the time you leave for work (P2), the time you arrive back home (P3) and the time you go to bed (P4).

Program	Mode	Time
☀️	☀️ Comfort	Wake-up time
☾	☾ Economy	Leaving time
☀️	☀️ Comfort	Return time
☾	☾ Economy	Bed time

For savings to be obtained, you must lower the temperature for a period of at least 2 times the delay required to bring the temperature back to your comfort level.

Example: If your system takes one hour to go from your economy temperature level to your comfort temperature level, it is unprofitable to lower the temperature for a period less than 2 hours.

a) To Program your Schedule:

- Press on PGM button to access the programming mode.
- Press on Day button to select the day to be programmed. You can select all days of the week by pressing on Day button for 3 seconds.
- Press on PGM button to select program 1, 2, 3 or 4.
- Press on Hour and Min buttons to program the time.
- When you have completed your programming, press on Mode/Return button to exit this function.

b) To Erase a Program:

Select the program using PGM and Day buttons, and press on Clear button. The time field displays --:-- when the program is inactive.

Example 1: Comfort period from 7:00 AM to 10:30 PM
Economy period from 10:30 PM to 7:00 AM
Identical schedule for all days of the week.

Schedule/Day	MON	TUE	WED	THU	FRI	SAT	SUN
PROG. 1 ☀️	7:00 AM	7:00 AM	7:00 AM	7:00 AM	7:00 AM	7:00 AM	7:00 AM
PROG. 2 ☾	---	---	---	---	---	---	---
PROG. 3 ☀️	---	---	---	---	---	---	---
PROG. 4 ☾	10:30 PM	10:30 PM	10:30 PM	10:30 PM	10:30 PM	10:30 PM	10:30 PM

- Press on PGM button to access the programming mode.
- Press on Day button 3 seconds to select every day of the week.
- Press on Hour button to enter 7:00 AM, Prog. 1 (☀️).
- Press 3 times on PGM button to select Prog. 4 (☾), and press on Hour and Min buttons to enter 10:30 PM.
- Press on Mode/Return button to exit this function.

Example 2: Comfort period Monday to Friday from 6:15 AM to 8:15 AM and from 5:00 PM to 10:00 PM.
Saturday and Sunday from 7:30 AM to 11:00 PM.

Schedule/Day	MON	TUE	WED	THU	FRI	SAT	SUN
PROG. 1 ☀️	6:15 AM	6:15 AM	6:15 AM	6:15 AM	6:15 AM	7:30 AM	7:30 AM
PROG. 2 ☾	8:15 AM	8:15 AM	8:15 AM	8:15 AM	8:15 AM	---	---
PROG. 3 ☀️	5:00 PM	5:00 PM	5:00 PM	5:00 PM	5:00 PM	---	---
PROG. 4 ☾	10:00 PM	10:00 PM	10:00 PM	10:00 PM	10:00 PM	11:00 PM	11:00 PM

NOTE: It is faster to program the same schedule for every day and then to modify certain days.

- Press on PGM button to access the programming mode.
- Press on Day button 3 seconds to select every day of the week.
- Press on Hour and Min buttons to enter 6:15 AM Prog. 1 (☀️).
- Press on PGM button to select Prog. 2 (☾) and Hour and Min buttons to enter 8:15 AM.
- Repeat step 4 to enter Prog. 3 (5:00 PM) and Prog. 4 (10:00 PM).

NOTE: When making modifications, make sure you are in the right program.

To modify the Saturday and Sunday schedules :

- Press on Day button until SA or SU is displayed.
- Press on PGM button to select Prog. 1 (☀️) and Hour and Min buttons to enter 7:30 AM.
- Press on PGM button to select Prog. 2 (☾) and then Clear button to erase it.
- Press on PGM button to select Prog. 3 (☀️) and then Clear button to erase it.
- Press on PGM button to select Prog. 4 (☾) and then Hour and Min buttons to enter 11:00 PM.
- Press on Mode/Return button to exit this function.

Temporary or permanent temperature bypass

This operation allows you to temporarily modify the temperature while you are in the Automatic mode. Simply press on ▲ ▼ buttons to select the desired temperature, or the ☀ or ☾ button to select the Comfort or Economy settings you have programmed. This temperature will be maintained until the beginning of the next program.

If you wish to immediately return to the programmed settings, press on Mode/Return button twice.

CHARACTERISTICS

- Model: DTW16S
- Supply: 220-240 VAC, 50 Hz
- Load: 15 A max. (resistive only)
- Power: 3450 W (NI)
- Display range: 0°C to 60°C (32°F to 140°F)
- Setting range: 5°C to 40°C (40°F to 104°F)
- Comfort default setting: 28°C (82°F)
- Econo default setting: 18°C (64°F)
- Vacation default setting: 10°C (50°F)
- Storage: -20°C to 50°C (-4°F to 120°F)
- Software: Class A
- Controller: Electronic
- Protection: Class 2
- Protection degree: IP20
- Automatic action: Type 1B
- Environment: Normally polluted
- Programming protection: Memory back-up
- Clock protection: 6 hours

The terminals are designed to handle a wire measuring 0.33 to 3.1 mm² in diameter.

Memory back-up

In the event of a power failure, an internal circuit will retain the programming and the time.

The time will have to be reset if the power failure exceeds 6 hours.

WARRANTY

DIMPLEX ONE (1) YEAR LIMITED WARRANTY

This product is warranted against material defects and workmanship in normal use for a period of one year, from the date of the original purchase from authorized dealers. During this period, Dimplex will repair or replace the product with a new or of equivalent quality at Dimplex's option, without charge, any product proven defective in normal use.

Warranty does not cover transportation costs. Nor does it cover a product subjected to misuse or accidental damage. This warranty does not cover the cost of installation, removal or reinstallation.

This limited warranty is in lieu of all other warranties, obligations or liabilities expressed or implied by the company. In no event shall Dimplex be liable for consequential or incidental damages resulting from installation of this product. Some states or provinces do not allow limitations on how long an implied warranty lasts, or the exclusion or limitation of incidental or consequential damages, so the above exclusions or limitations may not apply to you. This warranty gives you specific legal rights and you may also have other rights, which vary from state to state.

"Please do not initially return a faulty appliance or part of an appliance to us as this may result in transit damage and/or delay in providing service. Let us know your difficulty quoting the model number of the appliance. We will then take the appropriate action. Please retain receipt as proof of purchase."

Glen Dimplex UK Limited

**Millbrook House
Grange Drive
Hedge End
Southampton
Hampshire, SO30 2DF**

UK customer helpline

From 8:00 AM to 6:00 PM Monday to Friday and 8:30 AM to 1:00 PM Saturday)

Customer Services:

Tel.: 0870 727 0101
Fax: 0870 727 0102
Email: customer.services@glendimplex.com
Republic of Ireland:
Tel.: 01 8424833