

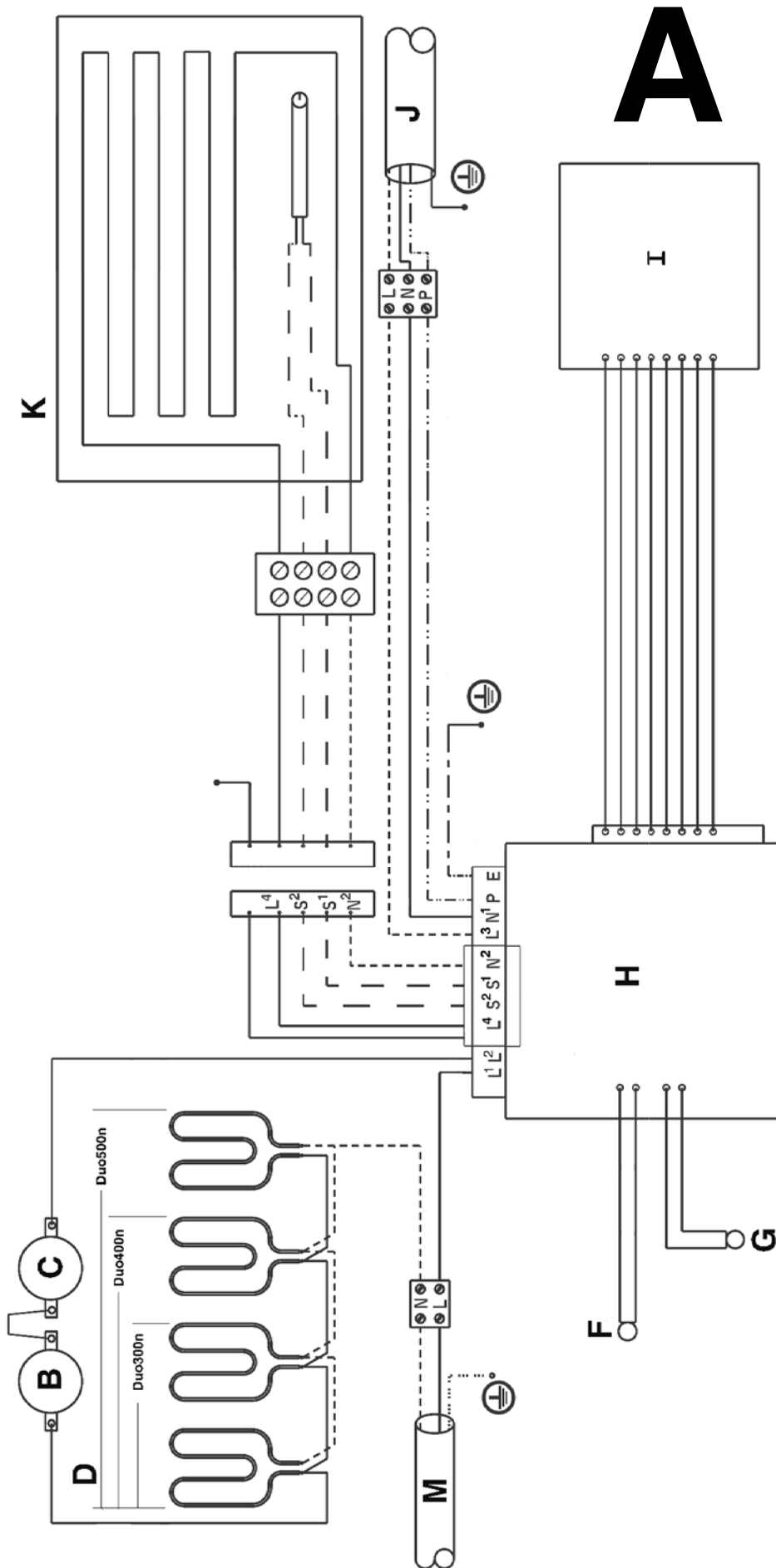

Installation Instructions

Duo300n	1.3kW / 0.38kW	9.1kWh
Duo400n	1.95kW / 0.47kW	13.65kWh
Duo500n	2.6kW / 0.54kW	18.2kWh



A	Circuit Diagram
B	Charge Control Thermostat
C	Over Temperature Cut Out
D	StorageHeater Elements
F	Room Sensing Thermistor
G	Core Sensing Thermistor
H	Charge Controller Module
I	User Interface Module
J	Peak Supply
K	Radiant Element
L	Live
N	Neutral
P	Pilot Wire
E	Manual Fit Connector
L1	Live Storage In
L2	Live Storage Out
L3	Live Radiant In
L4	Live Radiant Out
S1	Signal In
S2	Signal Out
N1	Neutral In
N2	Neutral Out
M	Off Peak Supply

Dimensions (including clearances diagram) (millimetres)

Dimensions (y compris l'espace libre) (millimètres)

Dimensões (incluindo diagrama de distâncias mínimas a manter) (milímetros)

Wymiary (w tym schemat minimalnych odległości) (w milimetrach)

Dimensioni (incluso lo schema degli spazi liberi) (millimetri)

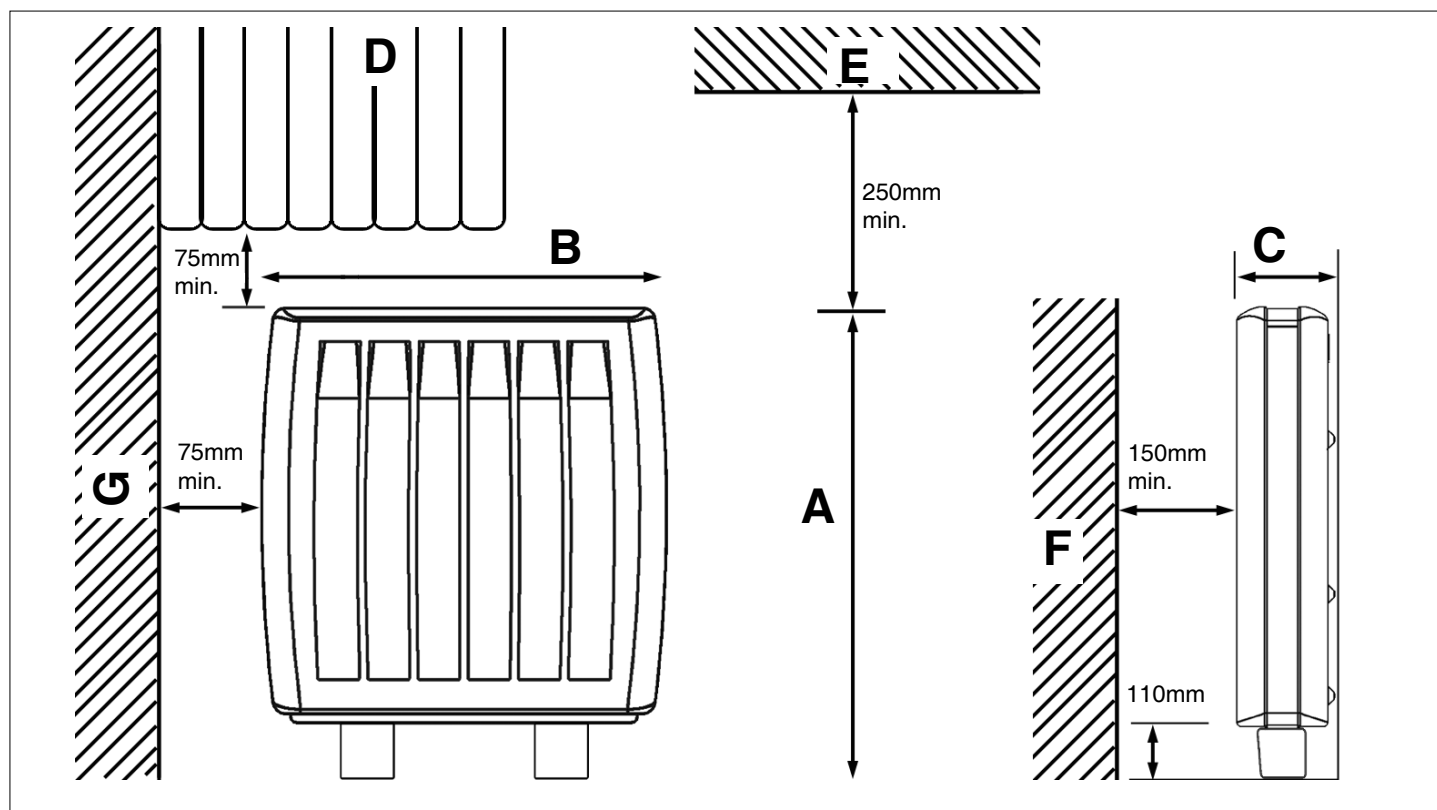

Model Modèle Modelo Modello Model	Height Hauteur Altura Altezza Wys. A	Width Largeur Comprimento Larghezza Szer. B	Depth Épaisseur Espessura Profondità Gleb. C
Duo300n	712mm	600mm	130mm+10mm
Duo400n	712mm	830mm	130mm+10mm
Duo500n	712mm	1060mm	130mm+10mm

D	Curtains	Rideaux	Cortinas	Tende	Firanki
E	Shelf or Overhang	étagère ou consoles murales	Prateleira ou objecto suspenso	Ripiano o sporgenza	Półka lub część wystająca
F	Furniture or other obstruction	Meubles ou autre obstacle	Mobiliário ou outro obstáculo	Mobile o altro oggetto	Meble lub inne elementy
G	Wall	Mur	Parede	Parete, tende o mobili	Ściany, firanki lub meble

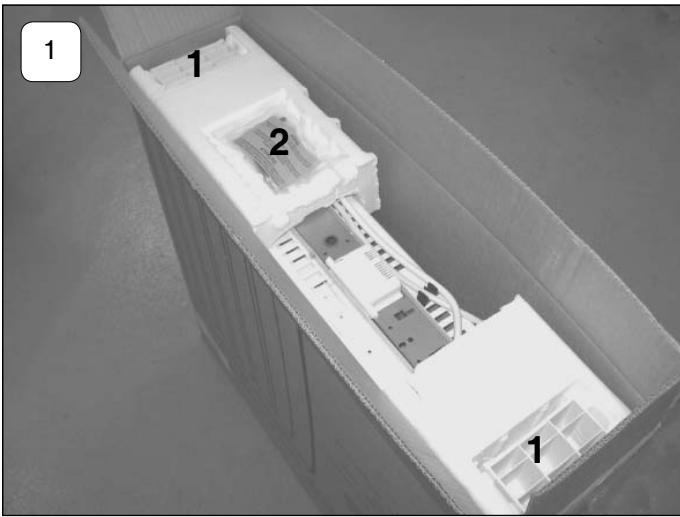

1. Feet 2. Accessories Bag
 1. Pieds 2. Sac à accessoires
 1. Pés 2. Saco de acessórios
 1. Piedini 2. Sacchetto accessori
 1. Nogo 2. Worek z akcesoriami

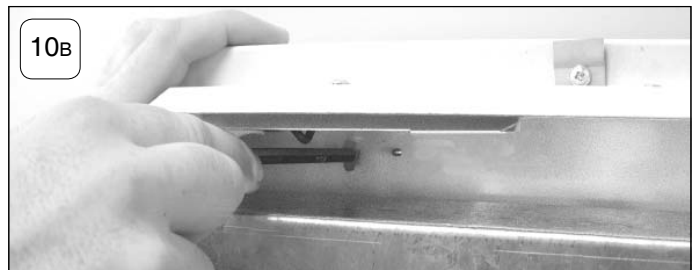
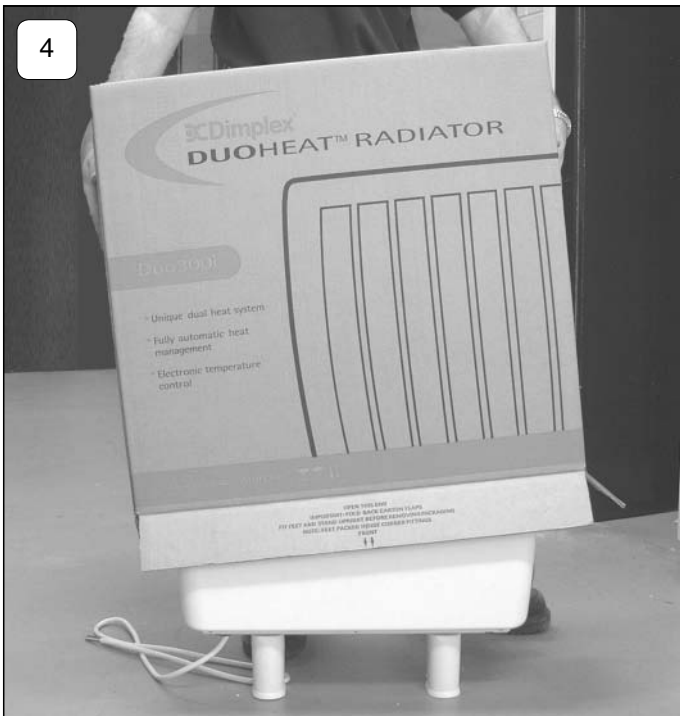
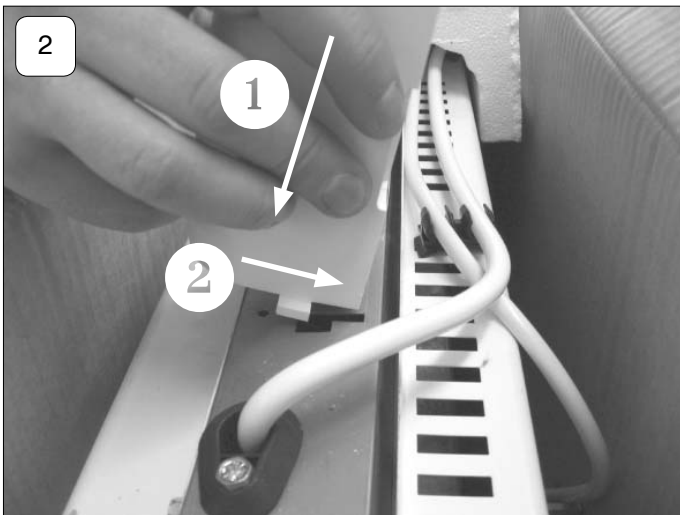
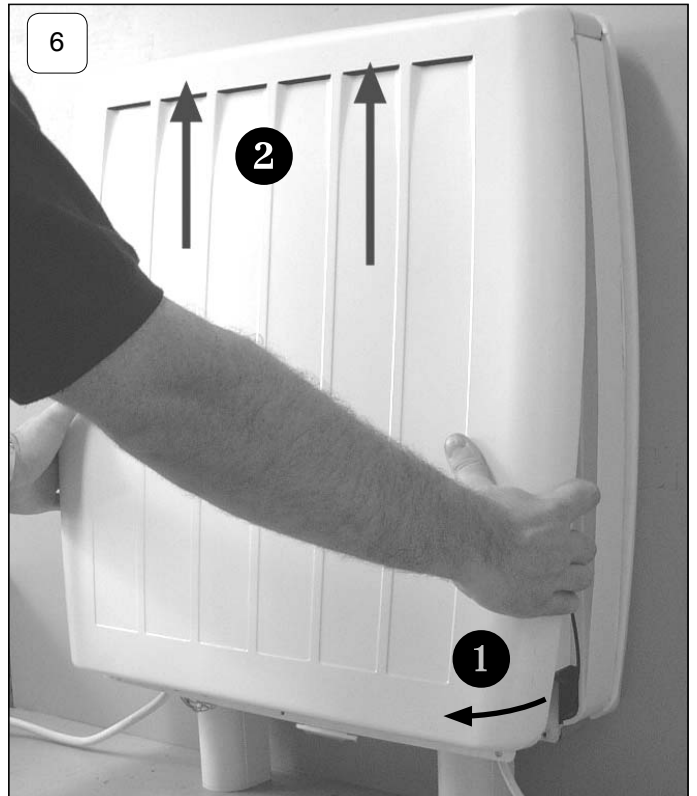

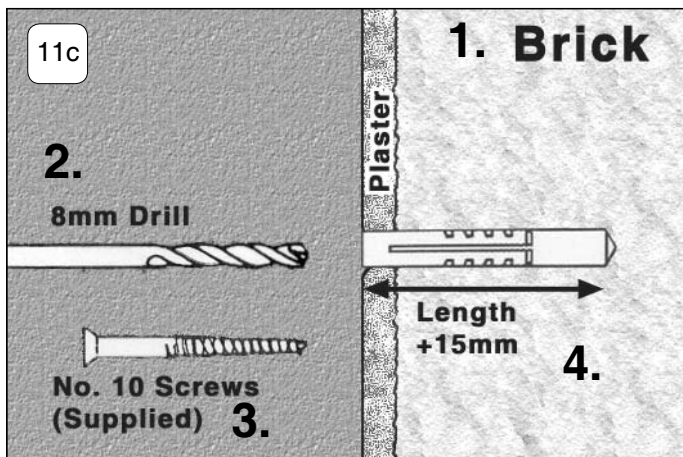
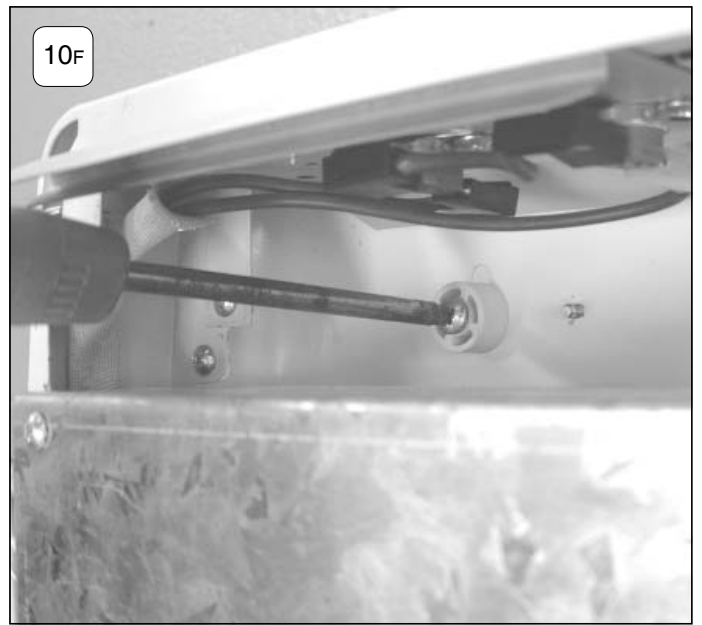

1. Brick 2. 8mm Drill 3. 3" No. 10 Screws (supplied)
4. Length +15mm

1. Brique 2. Foret 8mm 3. Vis N° 10 3" (fournies)
4. Longueur +15mm

1. Tijolo 2. 8mm Broca 3. 3" No. 10 Parafusos (fornecidos)
4. comprimento +15mm

1. Mattone 2. Punta da 8mm 3. Inserti in fibra n. 10 (in dotazione)
4. Lunghezza inserto +15mm

1. Cegla 2. Wierło 8mm 3. 3" No. 10 4. Długość kołka rozporowego +15mm

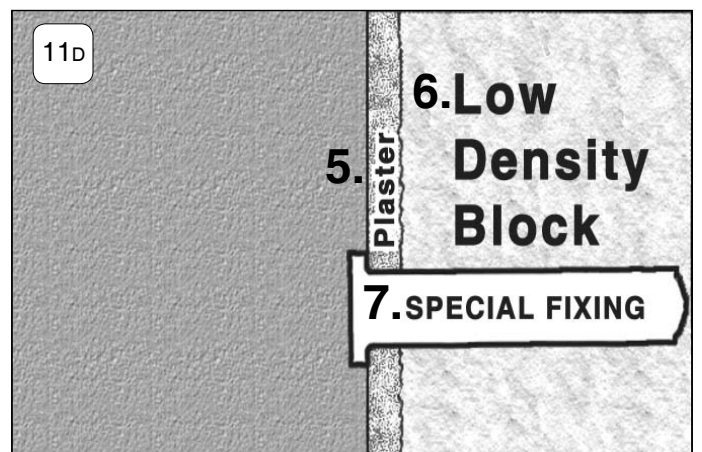

5. Plaster 6. Low density block 7. Special fixing
5. Enduit 6. Bloc de faible densité 7. Fixation spéciale
5. Estuque 6. Tijolo de baixa densidade 7. Fixação especial

5. Intonaco 6. Blocchi a bassa densità 7. Dispositivo di fissaggio speciale

5. Tynk 6. Material o małej gęstości 7. Plastikowy kołek rozporowy.

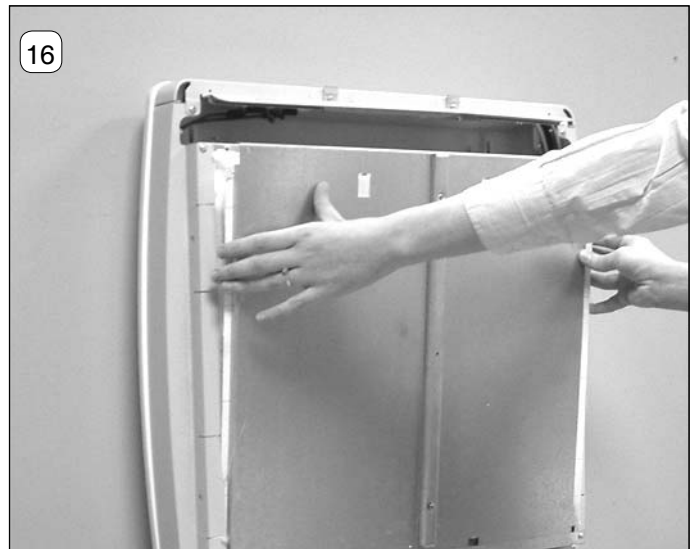
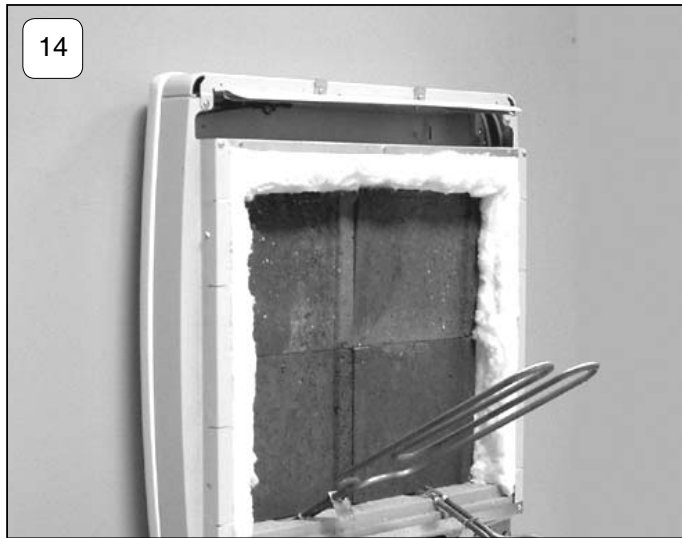
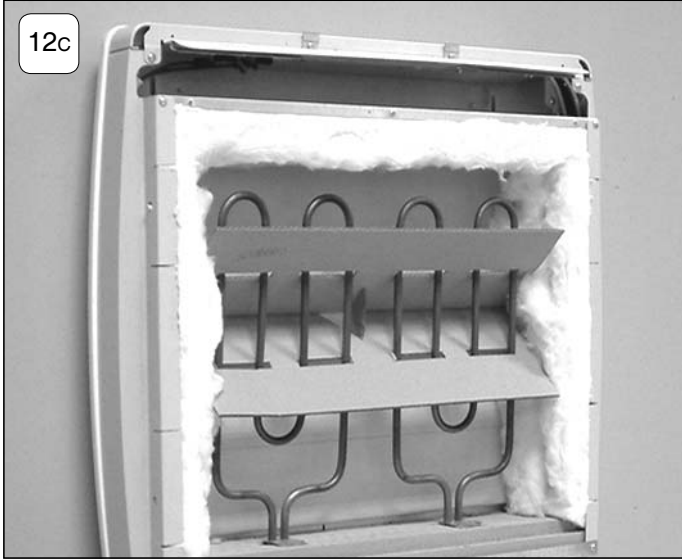
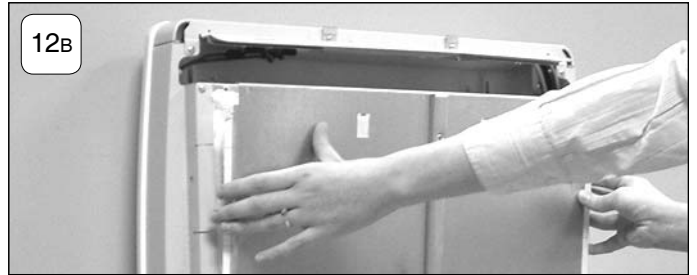

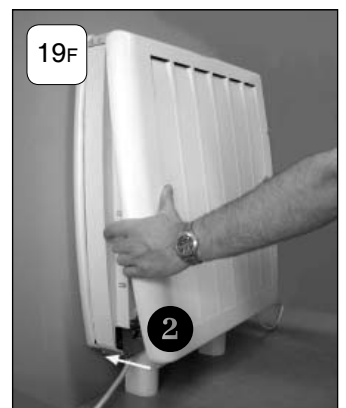
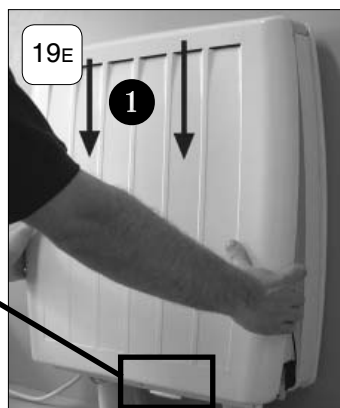
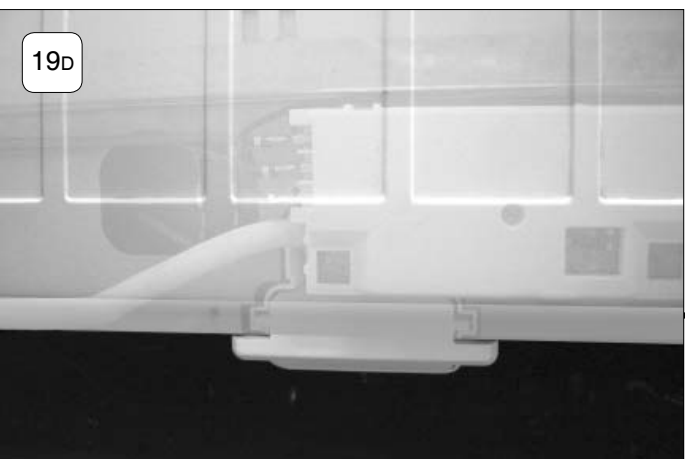
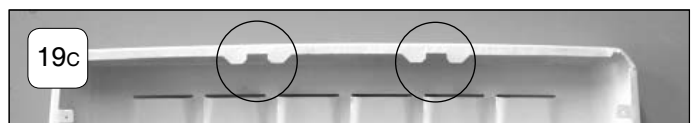
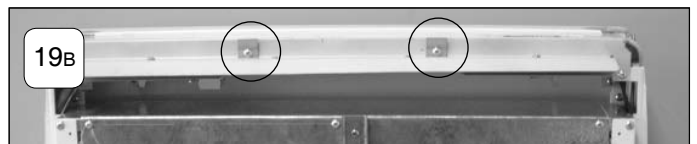
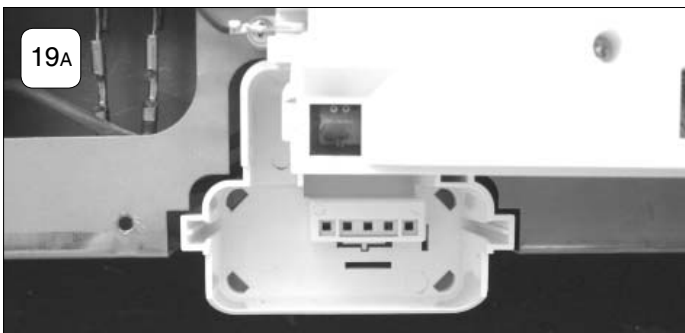
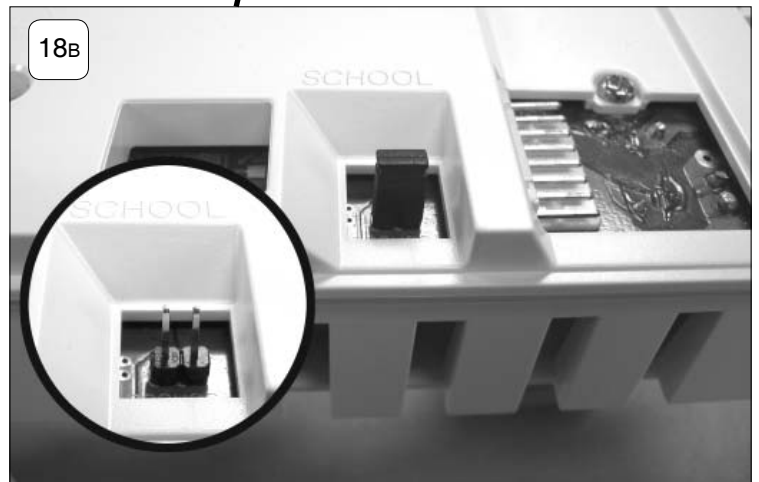
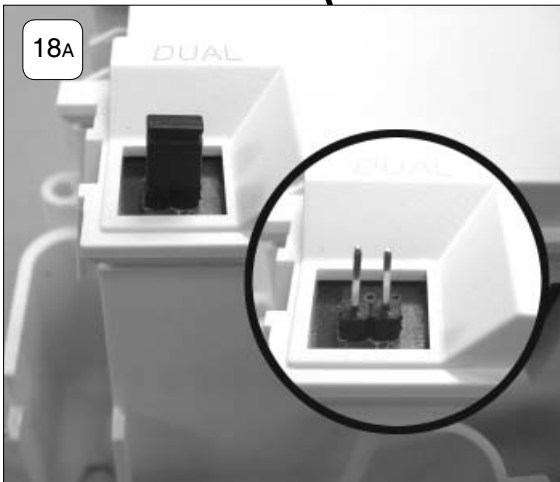

**THESE INSTRUCTIONS SHOULD BE READ CAREFULLY AND RETAINED FOR FUTURE REFERENCE
NOTE ALSO THE INFORMATION GIVEN ON THE APPLIANCE**

TO ENSURE THIS APPLIANCE IS OPERATING CORRECTLY, IT IS ESSENTIAL TO PERFORM THE CHECK PROCEDURE DETAILED ON THE BACK PAGE OF THIS INSTRUCTION. THIS *MUST* BE COMPLETED BEFORE NORMAL OPERATION COMMENCES.

IMPORTANT SAFETY ADVICE

WARNING - This radiator is VERY HEAVY, it is essential that the radiator is FIXED SOUNDLY TO A WALL and mounted on a FIRM, LEVEL SURFACE.

WARNING – Choose the appropriate fixings to securely attach the radiator to the wall;

Suggested Wall Fittings (see page 8 for further information)

Solid brick/block: Size 10 plastic inserts (provided). 8mm drill bit. Drill 15mm deeper than insert length.

Plasterboard: If possible locate studding and use No. 10 woodscrews directly into the wood, otherwise M5 intersets.

For other wall types seek specialist advice.

WARNING – If during any reassembly of the radiator, a part of the thermal insulation shows damage or deterioration which may impair safety, it should be replaced with an identical part.

WARNING – This radiator must not be located below a fixed socket outlet.

WARNING - in order to avoid overheating, do not cover the radiator.

DO NOT COVER OR OBSTRUCT the surfaces of the appliance.

DO NOT POSITION under windows where curtains may contact the radiator (see minimum clearances on Page 6).

DO NOT PLACE OBJECTS in contact with the radiator.

This appliance is not intended for use by persons (including children, who should be supervised) with reduced physical, sensory or mental capabilities, unless supervision or instruction has been given concerning use of the appliance by a person responsible for their safety.

DuoHeat Radiators are not suitable for installation in bathrooms, shower rooms etc. or in areas of high humidity.

Electrical Connection

WARNING – THIS APPLIANCE MUST BE EARTHED

The installation of this appliance should be carried out by a competent electrician in accordance with I.E.E. Regulations for Electrical Equipment. The radiator is fitted with two flexible cables for connection to the fixed wiring of the premises through suitable connection boxes positioned adjacent to the radiator. Each supply circuit to the radiator must incorporate a double pole isolating switch having a contact separation of at least 3mm. This radiator is **not** suitable for connection to a 30A ring circuit.



ATTENTION : IN ORDER TO AVOID OVER HEATING DO NOT COVER THE HEATER

Energy Retention Cells

Energy retention cells are supplied separately to the radiator in packs of two. The reference number is 85743.

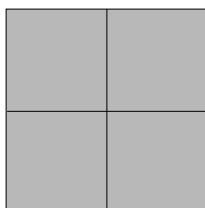

Duo300n
8 Cells (4 Packs)

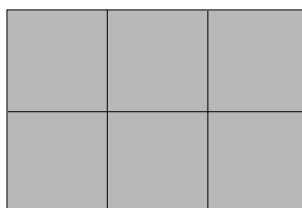

Duo400n
12 Cells (6 Packs)

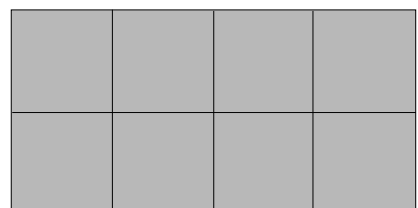

Duo500n
16 Cells (8 Packs)

INSTALLATION OF THE RADIATOR

ASSEMBLY

1. Open carton from the bottom. Remove feet and accessories bag from the polystyrene packaging. (Fig. 1)

2. Before removing the radiator from the carton, fit the feet to the radiator by engaging the flanges on the top of the foot with the slots in the base of the radiator
① Push the foot towards the back of the radiator until it is fully engaged ②. (Fig. 2)

3. The direct acting mains cable is clipped to the underside of the radiator ensuring it is secure during transit. The off peak mains cable will be secured with cable ties. Prior to installing the radiator, unclip the direct acting mains cable (do not remove or discard these clips).

NOTE: If the off peak mains connection is required to be made on the right hand side of the radiator, the pre-wired cable must be passed behind the feet and secured using the clips on the base of the radiator. For ease of access this should be done while the radiator is still upside down in the carton. Similarly when the direct acting mains cable is ready to be connected (See Section 19), if the connection is required to be made on the left hand side of the radiator the cable must be routed behind the feet. DO NOT clip the direct acting mains cable at this stage (See Section 19). The cable clips are already fitted at the factory to allow both mains cables to be attached, if required.

4. Stand the radiator on its feet and remove packaging. Remove all additional internal protective packaging. (Fig. 4)

5. Stand the radiator on its feet and against a wall. Remove the securing screws along the bottom edge of the front panel. (Fig. 5)

6. Carefully swing bottom of panel slightly away from the rest of the radiator ①, thus disconnecting the radiant element connector from the front panel, and lift upwards to unhook the top edge ②. (Fig. 6).

7. Ensure the electronic components are not damaged when removing the panel. Carefully place the panel to one side. Check that the mains supply cables are not damaged. If they are to be replaced only heat resistant cable must be used (min. T85) for both the off peak cable and peak. Refer to sections 3, 19 and 20 for fitting the off peak and radiant element cables.

8. Position radiator against wall in intended final position, ensuring it is on a firm base and taking note of the minimum fixing dimensions (see page 6).

9. If the floor is carpeted it is important that the feet are positioned firmly and securely. The feet may rest on top of the carpet, however carpet gripper should be removed around the feet so that the radiator rests in a level position.

WALL MOUNTING

The following must be applied before fixing the radiator to the wall:

NO SKIRTING BOARD / SKIRTING BOARD NO TALLER THAN 100MM

10A The radiator is to be mounted as shown in Fig. 10A, with the wall spacer bracket in its standard orientation.

10B Mark the position of the two mounting slots with the radiator pushed tight against the wall Fig. 10B.

10C Drill holes into the wall **toward the bottom** of the marked slots.

Use the 10mm spacers provided (4 x 10mm) between the rear of the radiator and the wall. DO NOT use the 30mm spacers where there are no skirting boards or they are no taller than 100mm.

10D Place one 10mm spacer to the inside and another 10mm spacer to the outside of the location hole on the back panel (see Fig 10A for wall spacer bracket orientation).

10E Carefully guide the radiator towards the drilled hole and screw **part way** to the wall Fig. 10E.

**DO NOT USE 30MM SPACER ON INSIDE OF RADIATOR.
USE ONLY EXTERNALLY - SEE FIG. 11A.**

**NOTE: UNDER NO CIRCUMSTANCES SHOULD THESE
SCREWS BE REMOVED WITHOUT FIRST REMOVING
ALL ENERGY RETENTION CELLS FROM THE RADIATOR**

10F Once both sides have been successfully positioned screw the radiator flush to the wall Fig. 10F.

Do not fully tighten these screws until the core has been loaded into the radiator as some settling of the radiator may occur.

11. SKIRTING BOARD TALLER THAN 100MM

Use the 10mm and 30mm spacers provided (2 x 10mm and 2 x 30mm)

11A If the skirting board is taller than 100mm, the radiator is to be mounted as shown in fig 11A. Remove the wall mounting bracket and reassemble in the alternative orientation to give a greater spacing distance from the wall.

11B Place the 30mm spacer to the outside of the radiator and the 10mm to the inside. Drill the holes as detailed in Section 10. Carefully guide the radiator towards the drilled hole. When in position screw **part way** to the wall to secure the radiator as in Section 10, **remembering not to fully tighten the screws.**

Solid brick/High density block walls - Fig. 11c

These must be drilled and plugged with the No. 10 size plastic inserts provided. The correct size of drill (8mm) should be used and the hole should be drilled to a depth of 15mm greater than the length of the plastic insert so that the fixing is made below the plaster layer.

Low density block walls - Fig 11d

A special fixing, such as Unifix LB70 should be employed, following closely the manufacturers instructions.

Panelled internal walls

If possible, locate the studding and use No. 10 size woodscrews. Where it is not possible to locate the studding use type M5 Rawlplug INTERSETS on securely fastened plasterboard panelling. For other wall materials the wall panel manufacturer should be consulted for details of suitable wall fixing devices.

12. Remove the inner front panel by removing the screws along its top edge Fig. 12A. Carefully lift the bottom of the front inner panel out of the retaining flange at the base of the radiator, Fig 12B and remove the internal packaging, Fig. 12c taking care not to damage the insulation attached.

13. Lift out the elements from the base insulation and rotate forwards. Fig. 13.

DO NOT DISCONNECT THE TERMINALS

14. Carefully fit the bottom row of the back layer of energy retention cells, placing the two end cells in position first **with the flat side toward the back**. Fit the top row of cells also with the recess toward the element. Fig. 14

15. Refit the elements by carefully feeding the tails down through the hole in the base insulation, ensuring the tab is pointing forward. Fit the front layer of cells with the flat side toward the front of the radiator. Ensure that the tab on the element is captured below the bottom row of cells and that the element is vertical. Fig. 15A & 15B.

16. Replace the inner front complete with insulation by locating its bottom edge behind the front lip of the chassis and inserting the retaining screws along the top and both sides. Fig. 16.

17. Check that the screws securing the radiator to the wall have been fully tightened. It is essential that all screws are replaced to ensure earth continuity.

Once installed DO NOT attempt to reposition the radiator without first unloading the energy retention cells and obtaining the services of a competent electrician.

RADIANT ELEMENT OVERRIDE

18. In its factory default setting, the radiant element will be allowed to operate for up to 2 hours after the beginning of the off peak charge period to maintain a comfortable room temperature if required. After 2 hours the radiant element will be automatically disabled until the end of the off peak charge period.

In circumstances where it will not be necessary to maintain a high ambient room temperature between the hours of typically 12am and 2am (for example a commercial application) this feature can be disabled by removing the time delay pin on the power enable board (see Fig. 18A), which will automatically switch the radiant element off at the beginning of the off peak charge period.

The ability to 'lock' the controls eg. school conditions, is achieved by removing the pin shown in Fig. 18B, which will prevent appliance settings being altered.

REASSEMBLY

19. Reconnect the radiant element connector as shown in Fig 19A-19F. Replace the outer front panel by hooking onto the two location clips on the top panel Fig. 19B, 19C & 19E. Swing the bottom of the front panel gently towards the radiator Fig. 19F until the radiant element connector is securely placed at the base of the radiator Fig. 19D.

**ON NO ACCOUNT SHOULD ANY SURPLUS CABLE BE PUSHED INSIDE OR BEHIND THE RADIATOR.
CHECK ALL ELECTRICAL CONNECTIONS FOR TIGHTNESS.**

ELECTRICAL CONNECTION IMPORTANT

20. The wires in the direct acting supply cable are coloured in accordance with the following code:

GREEN & YELLOW: EARTH

BLUE: NEUTRAL

BROWN: LIVE

BLACK: PILOT WIRE

The BLACK pilot wire is designed to carry a signal from a compatible remote programming device. If, however, a remote programmer is not being used, the appliance may be connected to the fixed wiring of the premises simply by cutting back the BLACK pilot wire, ensuring that it terminates within the outer insulating sheath of the supply cable.

DO NOT connect the BLACK PILOT WIRE to earth. When the programmer drives other radiators, connect the pilot wires together in series. Any 240V insulated cable may be used to link pilot wires around the ring main. A low signal current is used. Suitable connections would be either an additional single core wire marked or colour coded appropriately or use a 4 core cable throughout the radiator ring. As a mains conductor, the pilot wire should be isolated in accordance with the IEE regulations.

For further details of connection to Dimplex programming devices, please refer to the relevant Dimplex programmer instructions.

**REPLACING MAINS WIRE ON DIRECT ACTING
SUPPLY CIRCUIT
HEAT RESISTING CABLE MUST BE USED
(MIN. T85)**

CHECK PROCEDURE FOR INSTALLERS FOLLOWING INSTALLATION

THIS CHECK PROCEDURE SHOULD BE CARRIED OUR BY A COMPETENT INSTALLER ONLY.

THE OPERATING INSTRUCTIONS ARE AVAILABLE FOR END USERS.

DuoHeat has a built in self diagnostic function that enables both service engineers and end users to diagnose faults. Make sure that the peak supply is on before starting the diagnostic function.

Adjust the LED's down until only the blue frost protection LED is illuminated.

Press and hold the **⊖** button for 10 seconds until the blue LED goes off then release the **⊖** button.

The LED's will now come on one at a time - this indicates that the radiator is running the diagnostic checks.

A flashing LED will then illuminate to indicate a pass or fail.

Pass - 8th LED flashes - if Wall Mounted Programmer (RXPW4/RXMBS4) is not connected or in Comfort Mode.

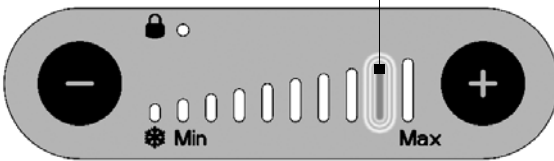

Pass - 9th LED flashes - if Wall Mounted Programmer (RXPW4/RXMBS4) is in Setback mode.

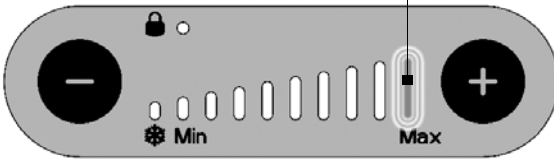

Fault Conditions

1st Red LED flashing - Room temperature sensor fault.

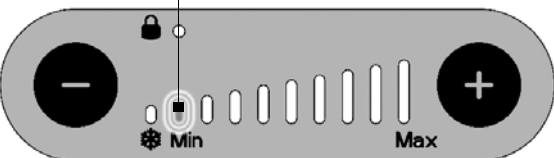

2nd Red LED flashing - Core temperature sensor fault.

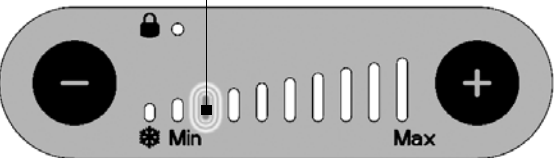

3rd Red LED flashing - Radiant Panel temperature fault.

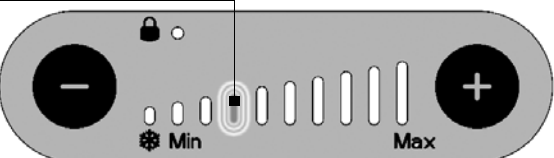

To exit diagnostic mode press either **⊖ or **⊕** to return to normal running mode.**

Contact Customer Helpline if any of the above faults are detected.

2. To check the radiant panel operation (comfort heat).

- (i) Adjust the temperature control display as follows; press down the **⊕** button until all red bars are illuminated (shown below). After 2 minutes the front panel should now feel warm, this will confirm correct operation.



- (ii) If the front panel does not heat up and room temperature is below 26°C, remove front panel and ensure there is no damage to front panel or radiant element and that all electrical connections are secure. If front panel is still not heating up, phone customer help line.

NOTE: If room temperature is above 26°C, radiator will not operate.

IMPORTANT

Once radiator has been confirmed as fully operational, use Page 2 of the 'Operating Instructions' to set up initial customer settings.

Please ensure the "Operating Instructions" are left with the radiator for user information.