

Contact Details

Please note that some of the contact details on this PDF document may not be current.

Please use the following details if you need to contact us:

Telephone: 0844 879 3588

Email: customer.services@gdcgroup.co.uk

The customer support section of our website also features a wide range of information which may be of use to you and is available 24 hours a day. It includes:

- Operating and installation instructions
- Easy 'How to use' guides for storage heaters
- Service and repairs
- Where to buy our products
- Literature downloads
- Heating requirement calculator

Visit - www.dimplex.co.uk/support

Lyndhurst Radiant Convector Fire

Model 430 RCE/B

T0104/004/B

Important Safety Advice

WARNING – THIS APPLIANCE MUST NOT BE USED IN A BATHROOM.

WARNING – DO NOT USE THIS HEATER IN THE IMMEDIATE SURROUNDINGS OF A BATH, A SHOWER OR A SWIMMING POOL.

WARNING – THIS HEATER MUST NOT BE LOCATED IMMEDIATELY BELOW A FIXED SOCKET OUTLET.

FOLLOW these instructions carefully.

NEVER cover or obstruct in any way the heat outlet slots at the top of the heater.

THE HEATER CARRIES A WARNING ‘DO NOT COVER’ TO ALERT THE USER TO THE RISK OF FIRE THAT EXISTS IF THE HEATER IS ACCIDENTALLY COVERED.

WARNING – THE SAFETY GUARD ON THIS APPLIANCE CONFORMS TO THE REQUIREMENTS OF BS1945 1971 AND SATISFIES THE HEATING APPLIANCES (FIREGUARD) REGULATIONS 1978. THE GUARD IS TO PREVENT THE RISK OF FIRE OR INJURY FROM BURNS AND SHOULD NEVER BE REMOVED PERMANENTLY.

If young children, the aged or infirm are likely to be left in the vicinity of the heater, we advise that adequate precautions should be taken. We recommend that a guard be fitted to ensure contact with the heater is avoided and objects cannot be inserted into the product.

For further information, please contact our guard supplier direct on Tel No 01603 667957, or in case of difficulty or for further advice contact the Customer Helpline – see page 4.

This heater is designed to meet the requirements of the relevant British and European Standards for safety. However, we do not recommend its use directly on deep pile carpets or long haired rugs.

CAUTION – DO NOT position curtains or furniture or other inflammable materials closer than 1 metre (39") in front of this heater - see also page 4.

CAUTION – DO NOT use this heater where excessive dust or moisture is present.

CAUTION – DO NOT use this heater in conjunction with an external thermal control, a programme controller, a timer or any other device which switches on the heater automatically, since a fire risk exists when the heater is accidentally covered or displaced.

Preparing for use

Unpack the heater carefully and retain the packaging for future use, in the event of moving or returning the heater to your supplier. Always ensure that the heater is stood on a firm, level surface. **IMPORTANT** - see Fig. 6, page 4 for clearance dimensions. See also 'Important Safety Advice'.

Electrical connection

WARNING – THIS APPLIANCE MUST BE EARTHED

This heater must be used on an \sim supply only and the voltage marked on the heater must correspond to the supply voltage.

This heater is fitted with a rewirable plug incorporating a 13 amp fuse. When replacing the fuse, a 13 amp fuse approved by ASTA to BS 1362 must be used. If the plug is not suitable for your socket, remove it and fit an appropriate plug.

IMPORTANT: If the plug is not suitable for your socket, the 13 amp plug should be removed. Before wiring the appropriate plug, please note that the wires in this mains lead are coloured in accordance with the following code:

BLUE – NEUTRAL
BROWN – LIVE
GREEN & YELLOW – EARTH

As the colours of the wires in the mains lead of this appliance may not correspond with the coloured marking identifying the terminals in your plug, proceed as follows:

Connect the BROWN wire to the terminal marked 'L' or coloured RED.

Connect the BLUE wire to the terminal marked 'N' or coloured BLACK.

Connect the GREEN & YELLOW wire to the terminal marked 'E' or \perp or coloured GREEN or GREEN & YELLOW.

If in doubt, consult your electrician.

IMPORTANT: If the mains lead is damaged, it must be replaced by a special lead or assembly available from Dimplex or an authorised Dimplex service agent.

Before switching on

Remove the fuel effect (two screws) and check that the lamps and flicker rotors are positioned correctly - see Fig 2, page 3.

The flicker rotors should sit horizontally on their pins and spin freely without fouling their mounting brackets. If necessary, adjust the bracket by bending slightly.

Refit the fuel effect by inserting the front edge first, then secure it with the two screws.

Ensure that all packing items are removed (read any warning labels carefully) and that the fuel effect and radiant elements are positioned correctly, otherwise damage may occur.

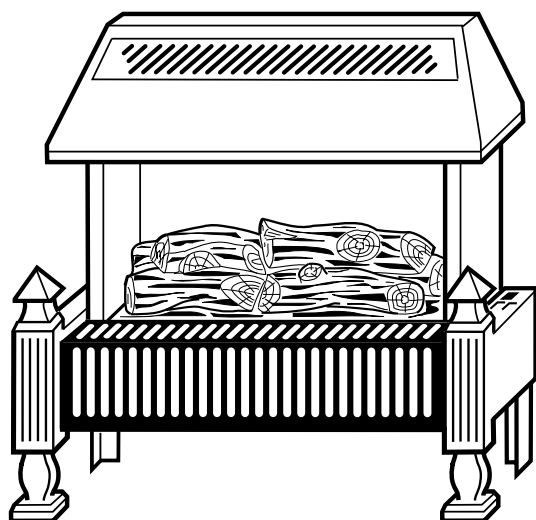

Operating position

Operation

When you are certain that you have completed the installation, plug in and switch on at the wall socket.

Controls - see Fig. 1

Fuel effect

The fuel effect will be lit all the time that the heater is connected to the power supply, even if the heat selector switches are in the OFF position. The flicker rotors should begin to rotate after a minute or so.

The lamps will go out only when the heater is switched off at the wall socket or unplugged.

Radiant elements

You have a choice of low heat (two elements, 1332W) or high heat (three elements, 1998W). Both settings have electronic temperature control - see below.

A switch is set to ON when the red dot is visible.

Low heat setting

Press switch **1** to ON. Two elements will glow and, when the temperature selected on the electronic control dial **4** is reached, one of the elements will automatically turn off, switching back on if the temperature falls.

See also 'Electronic economiser temperature control' below.

High heat setting

Set switches **1** and **2** to ON. All three elements will glow and, when the temperature selected on the electronic control dial **4** is reached, two of the elements will automatically turn off, switching back on if the temperature falls.

The fire can be returned to low heat setting by pressing switch **2** to OFF.

See also 'Electronic economiser temperature control' below.

Convactor heater

The 700 watt convactor heater can be used by itself for background heating, or in conjunction with the radiant elements for extra heat.

The convactor output is through the vent in the canopy. **This vent must never be covered or obstructed.**

Press switch **3** to the ON position. Warm air will now come through the vent in the canopy until the temperature selected on the electronic control dial **4** is reached. The convactor heater will then turn off automatically, switching back on if the temperature falls.

See also 'Electronic economiser temperature control' below.

Electronic economiser temperature control

This sensitive output control **4** will switch the radiant and convactor heater elements ON and OFF to accurately maintain the level of comfort that you have selected.

Select the heat required - convactor and/or low or high radiant setting - then turn the control dial to 7; when the room reaches a comfortable level of warmth, turn the dial down until the electronically controlled elements switch off. The control dial should be left at this setting; the electronic control will then switch the elements ON and OFF as needed to maintain your chosen comfort level.

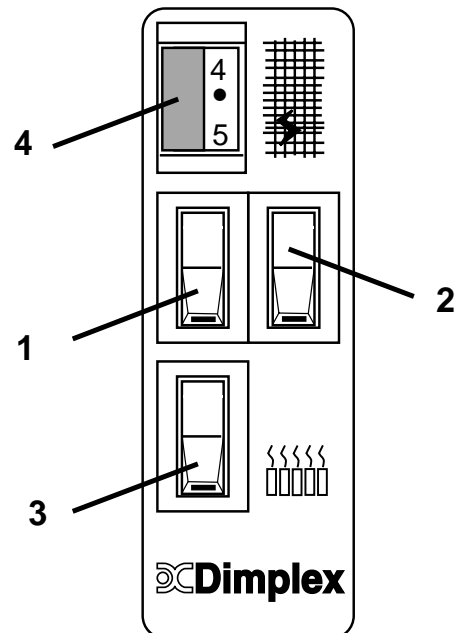

Fig. 1

Maintenance

WARNING: ALWAYS DISCONNECT FROM THE MAINS SUPPLY BEFORE ATTEMPTING ANY MAINTENANCE

Access to flicker rotors and lamp replacement – see Fig. 2

The fuel effect is secured by two screws, one at each end. Slacken these screws (do not remove them completely) until the fuel effect is released, then lift it clear. Ensure that the screws are partially inserted into the fuel effect before refitting it.

Each flicker rotor should sit horizontally on its pin and spin freely without fouling its mounting bracket. If necessary, adjust the bracket by bending slightly (the plastic diffuser material is flexible).

To replace a lamp, bend up the defective lamp's flicker rotor top bracket arm carefully and lift off the rotor.

Replace the defective lamp with a 60 watt B22 fuel-effect lamp.

Reassemble in reverse order, ensuring that the diffuser/top bracket arms are positioned correctly and the flicker rotors spin freely.

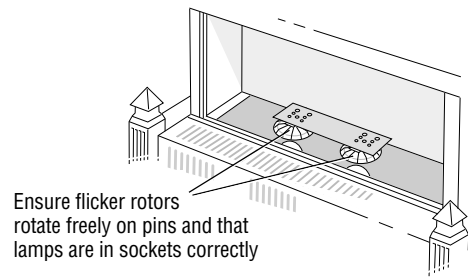

Fig. 2

Removing the guard – see Fig. 3

Unscrew the two screws at each end of the guard, then withdraw the lower edge of the guard first. Refit the guard in reverse order.

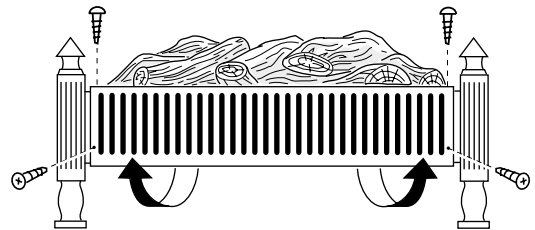

Fig. 3

Removing the radiant elements – see Fig. 4

First remove the guard, as detailed above.

The element holders are spring loaded. To remove an element, grip one end using a soft cloth to protect the surface, then push carefully but firmly to one side until the other end disengages from its socket. Withdraw the element carefully. Refit in reverse order.

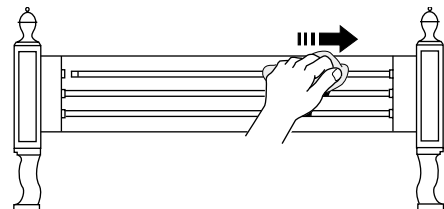

Fig. 4

Cleaning the reflector – see Fig. 5

The reflector may be more easily cleaned if the elements are first removed (see above).

Wipe the reflector with a warm soapy cloth, then buff with a soft dry cloth. DO NOT use abrasive cleaning powders or metal polish.

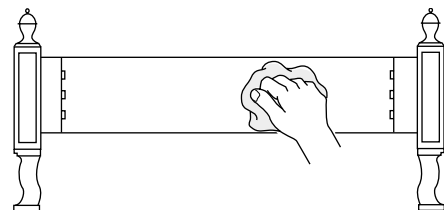

Fig. 5

IMPORTANT

ENSURE THAT THE HEATER IS POSITIONED IN ACCORDANCE WITH THE MINIMUM CLEARANCE DIMENSIONS GIVEN BELOW.

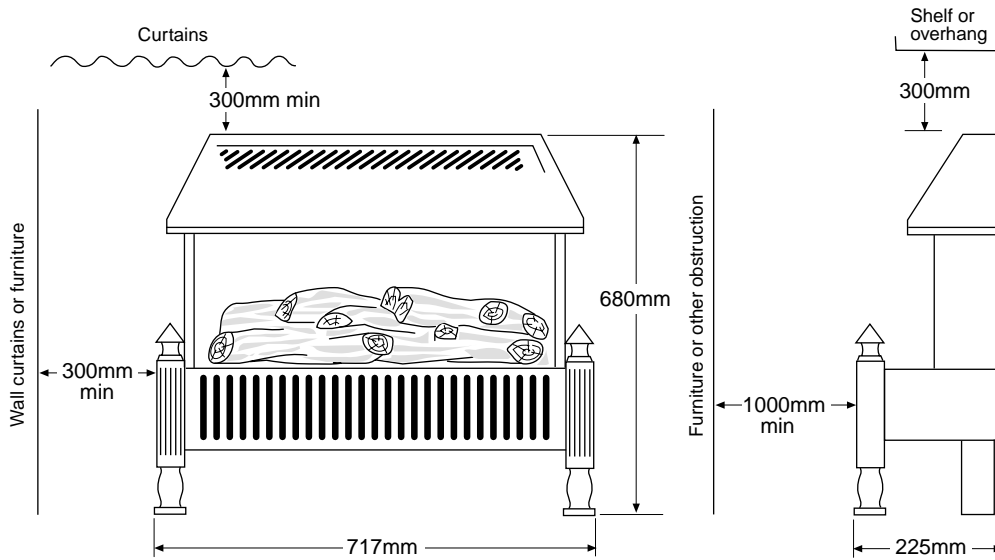

Fig. 6

Cleaning

WARNING – ALWAYS DISCONNECT FROM THE POWER SUPPLY BEFORE CLEANING THE HEATER.

Do not use detergents, abrasive cleaning powder or polish of any kind on the body of the heater.

Allow the heater to cool, then wipe with a dry cloth to remove dust and a damp cloth (not wet) to clean off stains. Be careful not to allow moisture into the heater.

After Sales Service

Your appliance is guaranteed for 1 year from the date of purchase. We undertake to repair or exchange, free of charge within the guarantee period, any part found to be defective, excluding lamps. Your rights under this guarantee are additional to your statutory rights, which in turn are unaffected by this guarantee.

If your appliance is not working correctly, please contact our Customer Helpline on 0870 727 0101.

This guarantee only applies in the United Kingdom.

Specification subject to change without prior notice.

This appliance complies with European Safety Standards EN60335-2-30 and European Standards EN55014, EN60555-2 and EN60555-3 for electromagnetic compatibility.

These standards cover the requirements of EEC Directives 73/23 and 89/336.



Dimplex Glen Dimplex Heating Limited
Millbrook
Southampton
SO15 0AW

UK Customer Helpline (8am-6pm Mon-Fri; 8:30am-1pm Sat.)
Tel: 0870 727 0101
Fax: 0870 727 0102
Republic of Ireland: 01 842 4833

T0104/004/B