

PIR Activated Delay Timer / Thermostat - Model No. PX9700/PX9900

T0002/004/B

Main Dimensions

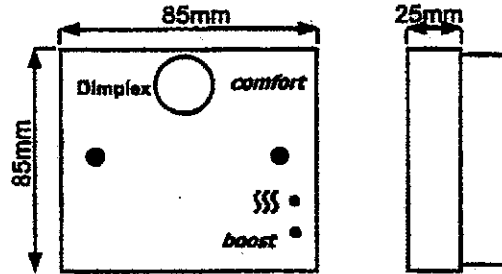

Ensure 500mm clearance from any heat source or draught.

Safety Warnings

1. WARNING: DO NOT USE THIS APPLIANCE IN THE IMMEDIATE SURROUNDINGS OF A BATH, A SHOWER OR SWIMMING POOL
2. WARNING: DO NOT USE WHERE EXCESSIVE DUST OR MOISTURE IS PRESENT
3. WARNING: FOR USE IN NORMAL POLLUTION SITUATIONS ONLY

General Description

The PX9700/PX9900 delay timer/thermostats are PIR activated electronic controls for remote operation of heating appliances. The PX9700 has two heating modes (comfort and setback) and the PX9900 has 3 heating modes (comfort, setback and frost protection / holiday mode). They may be flush or surface mounted using a standard 25mm box. The control is rated at 16A (250VAC) and can be used in conjunction with heating appliances with a maximum total input of 13 A resistive L.C. 230V - 50Hz. The controller cannot be used with a Quartz heater without a suitable in-line contactor. Control action: Type 1B

Operating Instructions

The PX9700 will control the heater to provide a continuous level of background heat when the room is unoccupied. The level of background heat required (setback temperature) should be preset during installation.

When occupancy is detected the PX9700 control will bring the room temperature up to the comfort temperature selected during installation for a preset time period, also set during installation. When the comfort heating period has elapsed the heating will be set back to background temperature, until further occupancy is detected.

The operation of the PX9900 is identical to the PX9700 except that if no further occupancy is detected after 8 hours in setback mode, the unit will automatically switch to frost protection (5°C). The frost protection setting is preset and requires no adjustment by the installer.

If occupancy is detected with the PX9900 in frost protection mode, the heating will switch immediately to comfort mode.

boost

When occupancy is detected the comfort mode is activated and the green light illuminates. The comfort mode allows the room to be heated to a pre-determined temperature for a pre-determined time period.



The red light indicates that the heater is operating. Note that the heater will remain on for a minimum of 1 minute.

The red light may also be illuminated in the set back mode when the PX9700/PX9900 switches the heater on to maintain the predetermined background temperature.

The PX9700/PX9900 controls room temperature by interrupting the power supply to the heater, therefore the heater should always be switched on and its integral thermostat (if fitted) set to maximum temperature.

Installation

Before undertaking installation work, ensure the electricity supply is disconnected from any relevant fixed wiring.

1. The control and heater should be installed in compliance with the IEE Wiring Regulations
2. The location of the control is important, it will not function correctly if above or within 500mm of a heat source or draught. Care must also be taken not to obscure the slots at the top or bottom of the control and that it is not exposed to direct bright sunlight or close to a lamp fitting. Best temperature accuracy will be achieved by mounting on an internal wall or partition.

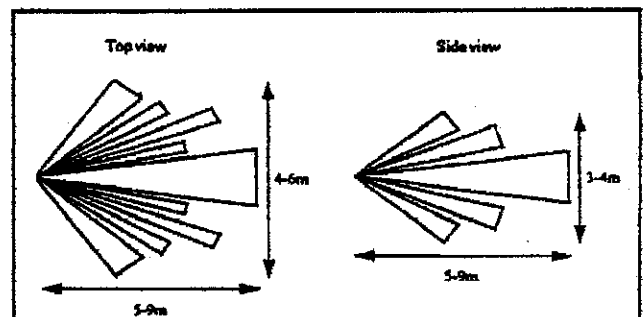

3. The control must be mounted in a location that allows the PIR detector good unobscured coverage of the room occupants (see detector pattern above). Normally mounting at wall switch height is desirable.

Installation contd..

Rx 9700 Rx 9900

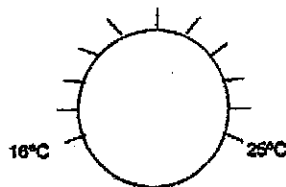
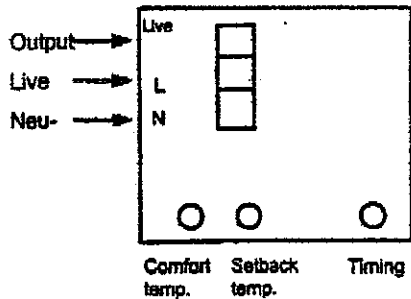

Comfort Temperature °C

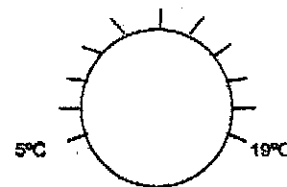

Setback Temperature °C

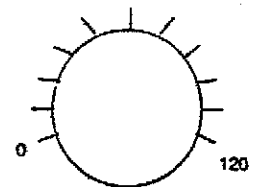

Timing (Mins)

- 6. The supply cable is not provided and should therefore be selected to suit the appliance.

Warning: Although the control does not need an earth, the appliance probably does. Ensure that the mounting box is fitted with an earth terminal for earth continuity to the appliance.

- 7. To connect the control in circuit wire in to the clearly marked terminal block on the rear of the controller. The control must only be connected via fixed wiring.

Wiring Diagram

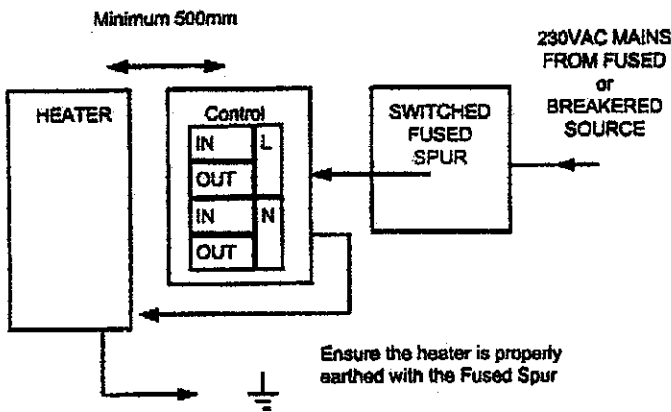

Alternative

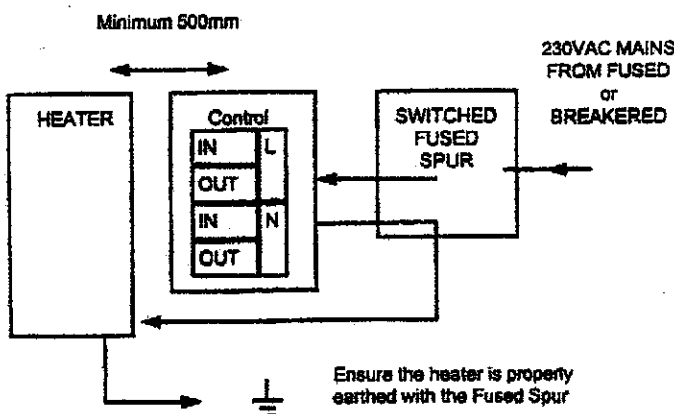

- 8. Secure the control to the pattress box such that there are no gaps between the controller and wall or pattress box.

Note: If tamperproof screws are required they should be M3 x 40mm long, counter sunk with a head diameter of no more than 6.5mm.

General Cleaning

WARNING
BEFORE UNDERTAKING CLEANING WORK ON THE CONTROLLER OR APPLIANCE IMMEDIATELY DISCONNECT THE ELECTRICITY SUPPLY BY SWITCHING OFF AT THE ADJACENT DOUBLE POLE SWITCH.

The outside of the appliance should be wiped over with a soft damp cloth and then dried. Do not use detergents or abrasives.

After Sales Service

Your Dimplex Comfort Control is guaranteed for one year from date of purchase. We undertake to exchange or repair free of charge within this period, any part found to be defective.

Should you require after sales service, please get in touch with the supplier through whom you purchased the appliance, or your nearest Service Agent.

Please do not initially return a faulty appliance or part of an appliance to us as this may result in transit damage and/or delay in providing service. Let us know your difficulty quoting the model number and series of the appliance. We will then take the appropriate action.



Glen Dimplex Manor House Avenue Customer Help Line (0870) 727 0101
 Millbrook Product Sales (0870) 727 0103
 Southampton Head Office (0870) 077 7117

2