

UNIDARE

WMCS(N) COMBINED AUTOMATIC STORAGE AND CONVECTOR HEATER

MODELS:

WMCS712N	1.7kW/12kWh Storage and 1kW Convector
WMCS718N	2.55kW/18kWh Storage and 1.5kW Convector
WMCS724N	3.4kW/24kWh Storage and 2kW Convector

INSTALLATION AND OPERATING INSTRUCTIONS

IMPORTANT

PLEASE READ THIS LEAFLET CAREFULLY AND RETAIN FOR FURTHER USE.

NOTE ALSO THE INFORMATION GIVEN ON THE HEATER

- ✦ The Installation must be carried out by trained personnel.
 - ✦ A means for disconnection must be incorporated in the fixed wiring by a double pole switch with a contact separation of a minimum of 3mm and in accordance with the current IEE Wiring Regulations.
 - ✦ The heater must not be installed immediately below a fixed socket outlet.
 - ✦ The heater is not suitable for connection to a 30A ring circuit.
 - ✦ Do not position the heater under windows where curtains can contact the heater casing.
-
- ✦ **WARNING - THE SURFACES ON THIS HEATER CAN BE HOT.**
 - ✦ This heater meets EN60335 safety requirements. However, any heater type becomes hot in normal operation. Care must be taken to ensure that prolonged skin contact with the heater does not occur.
 - ✦ **WHERE YOUNG CHILDREN, INFIRM PERSONS, OR THE AGED ARE PRESENT THIS APPLIANCE MUST BE ADEQUATELY GUARDED.** Contact your installer or the manufacturer for further advice.
 - ✦ This appliance is not intended for use by persons (including children) with reduced physical, sensory or mental capabilities, or lack of experience and knowledge, unless they have been given supervision for instruction concerning use of the appliance by a person responsible for their safety. Children should be supervised to ensure that they do not play with the appliance.
 - ✦ This appliance is very heavy and must be securely fixed to a wall. **DO NOT UNDER ANY CIRCUMSTANCES ATTEMPT TO MOVE OR REPOSITION THIS HEATER WITHOUT SEEKING EXPERT ADVICE.**
 - ✦ To maintain stability, it is essential that the heater is placed on a level surface.
 - ✦ This heater must be installed where it is impossible for switches and other controls to be touched by a person using a bath or shower.
 - ✦ **IMPORTANT - Due to the newness of materials the heater will produce a slight smell for the first few days of operation. ROOMS MUST BE WELL VENTILATED AND YOUNG CHILDREN, CAGED BIRDS, OR PERSONS WITH RESPIRATORY COMPLAINTS MUST NOT REMAIN IN CLOSE PROXIMITY TO THE HEATER DURING THE FIRST 48 HOURS OF THE COMMISSIONING PERIOD.**
 - ✦ **IF, DURING ANY REASSEMBLY OF THE HEATER, A PART OF THE THERMAL INSULATION SHOWS DAMAGE OR DETERIORATION WHICH MAY IMPAIR SAFETY, IT SHOULD BE REPLACED BY AN IDENTICAL PART.**

INSTALLATION INSTRUCTIONS

PREPARATION

The heater will arrive separately from its storage bricks, the following bricks will be required.

Model 712N - 8 bricks
Model 718N - 12 bricks
Model 724N - 16 bricks

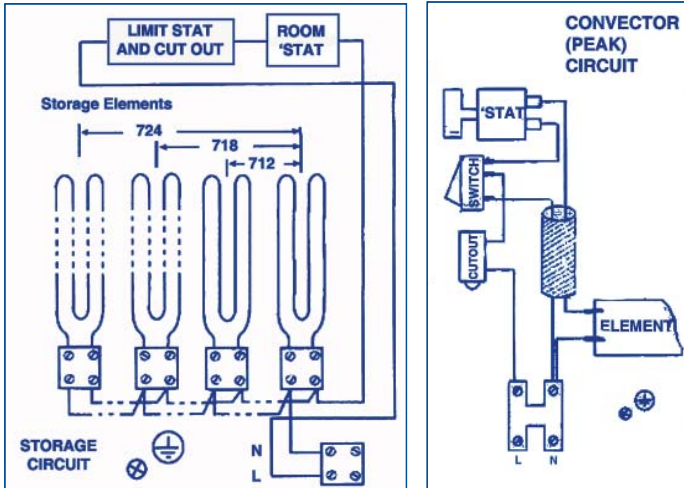

3. Place the heater on its feet and in the desired position against the wall. Ensure the heater is based on a firm level surface at least 75mm from any end wall and at least 250mm below any shelf or similar projection. Cut away any gripper rod or carpet which would prevent the heater sitting firmly on the floor.

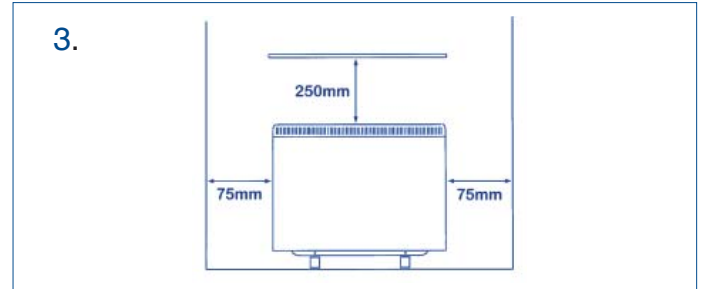

4. Mark the position of the two outside corners of the wall bracket with the heater pushed tight against the wall. Remove the wall bracket from the heater by removing the screw at each end. Place the heater to one side and reposition the bracket against the wall using the corner marks for alignment.

Four fixing positions must be chosen for the 724N, three for the 718N and two for the 712N. Mark the positions for the fixing holes - two at the extreme ends and the others spaced evenly between them. Remove the bracket from the wall, drill the holes in the positions marked, and insert suitable fixings previously described. Secure the wall bracket to the wall.

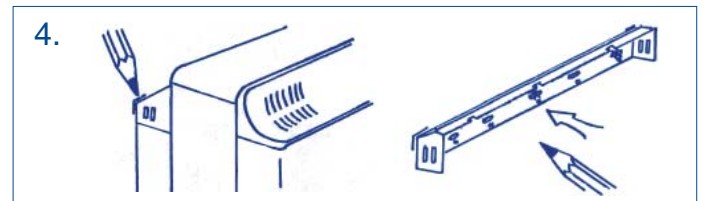

5. If mains connection is to be made from the left hand side, at this point the mains lead must be secured to the back of the heater using ties provided in the fixing kit.

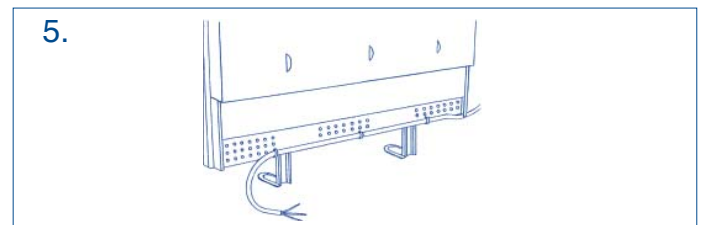

6. THE FOLLOWING MUST BE APPLIED WHEN FIXING THE HEATER TO THE WALL BRACKET

- i) If no skirting board is present secure the heater through the wall bracket slots closest to the wall.
- ii) If 100mm (4in.) skirting is present secure the heater through the outer slots.
- iii) If skirting taller than 150mm (6in.) is present this must be reduced to 150mm (6in.) over the entire width of the heater plus 25mm (1in.) at each end.

Do not fully tighten these screws until the bricks are loaded into the heater as some settling of the heater may occur.

NOTE: NEVER REMOVE THESE SCREWS WITHOUT FIRST UNLOADING THE HEATER.

WARNING - This appliance must be earthed.

Only heat resisting cable (min. rating T85) should be used. The wires in the mains cable will be coloured as follows;

GREEN & YELLOW	-	EARTH
BLUE	-	NEUTRAL
BROWN	-	LIVE

SUGGESTED FIXINGS

SOLID BRICK/BLOCK - No. 10 size plastic inserts, 8mm drill bit. Drill hole 15mm deeper than plastic insert length.

PLASTERBOARD - If possible locate studding and use No. 10 woodscrews directly into the wood, otherwise M5 rawplug intersets are suitable.

NOTE: FOR ALL OTHER WALL TYPES (e.g. Timber frame and hollow concrete) **SEEK SPECIALIST ADVICE.**

FIXING ASSEMBLY

1. ENSURE THAT FIXING KIT AND FEET HAVE BEEN LOCATED BEFORE DISPOSING OF PACKAGING.

2. Fit the feet with the open end of the foot to the front of the heater. Secure each foot using the two tapitite screws provided.

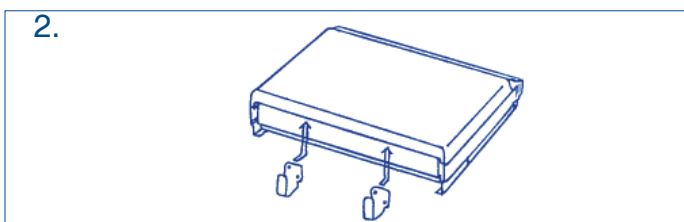

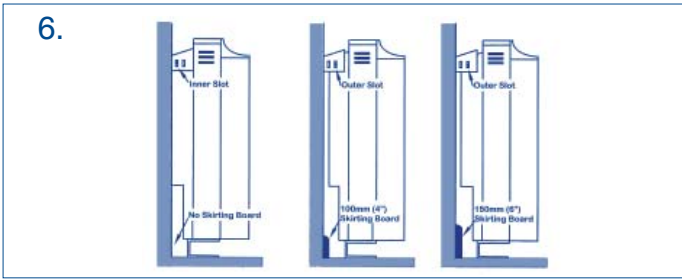

7. Remove the front panel by removing the two self tapping screws along its bottom edge. With hands positioned on each side of the panel, lift upwards to unhook the top edge whilst pressing down on the top panel with your thumbs. Ensure the convector element is not damaged when placing this panel to one side.

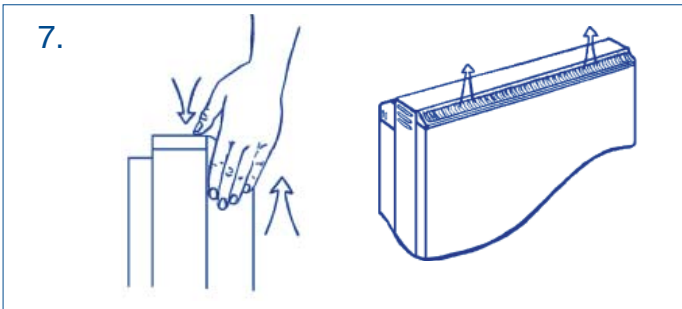

8. Remove the inner front panel by removing the screws along its top and sides. As the front insulation is attached care must be taken when lifting this panel from the heater and placing it to one side. Remove the internal packing by sliding it up and off the elements taking care not to damage the insulation.

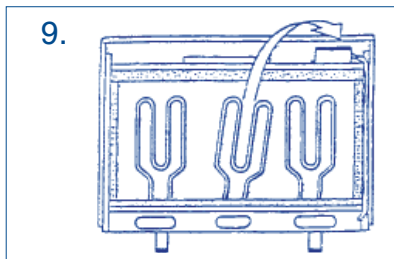
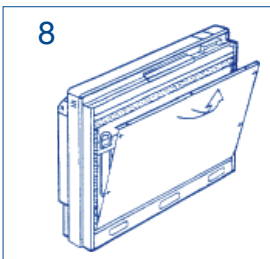

9. Remove one element to allow access for the back row of bricks. On the 724N remove the element to the right of centre, on the 718N remove the central element, on the 712N the left hand element should be removed. Loosen the two screws securing the element tails in the ceramic connector block, and lift the element up and out of the heater.

10. Carefully fit the bottom row of the back layer of bricks placing the two end bricks in position first with the recess towards the element. Fit the top row of bricks also with the recess towards the element.

11. Refit the element which has been removed by feeding the tails down through the hole in the base insulation and into the connector block. Ensure the element is fully pushed home then securely tighten the two screws in the block.

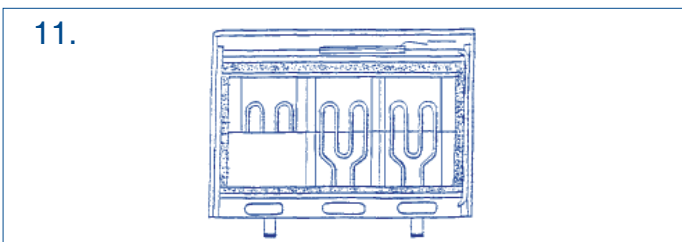

12. Fit the front layer of bricks again with the recess towards the element. The complete core will comprise:

- 712N - 2 x 4 Brick Columns
- 718N - 3 x 4 Brick Columns
- 724N - 4 x 4 Brick Columns

13. Replace the inner front complete with insulation by locating its bottom edge behind the front lip of the chassis and inserting retaining screws along the top and both sides.

14. Check that the flap mechanism operates freely on its hinges and that with the output control set to 1 the flap is correctly seated in its closed position.

15. **Connection of Supply to Storage** - Feed the mains cable through the cable clamp and make connections as marked on the heater. Pull back any slack through the clamp and tighten clamping screw.

WARNING - This appliance must be earthed.

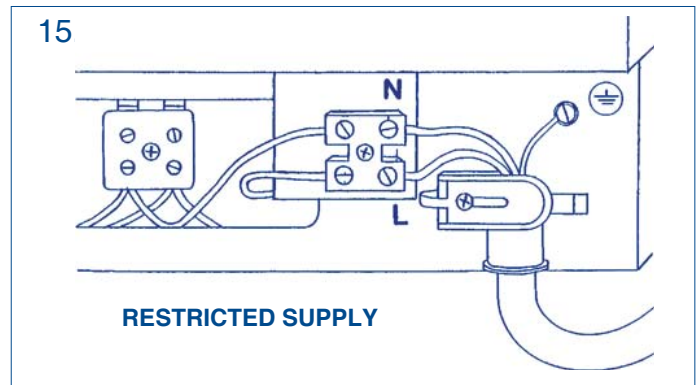

16. **Connection of supply to Convector** is through a cable clamp in the case of the front panel.

Connect the wires as detailed below, pull back any slack through the cable clamp and tighten clamping screws, see picture 16.

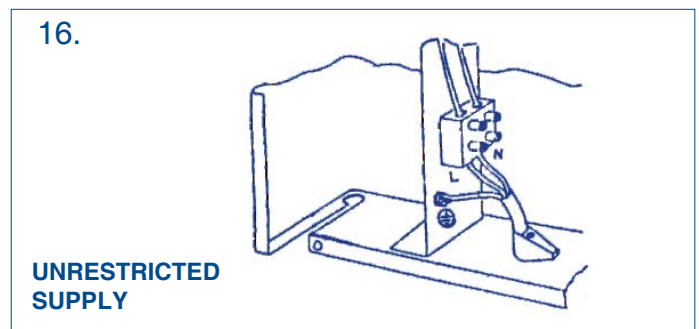

17. Replace the outer front panel and grille by hooking the grille into its retaining slot on the top panel and lowering it into position. Secure the front panel with two self tapping screws.

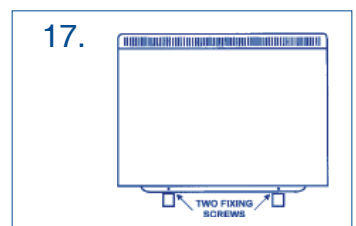

18. Check that the screws securing the heater to the wall bracket have been fully tightened.

IT IS ESSENTIAL THAT ALL SCREWS ARE REPLACED TO ENSURE EARTH CONTINUITY.

Once installed do not attempt to reposition the heater without first obtaining the services of a competent electrician.

OPERATING INSTRUCTIONS

OPERATION

Your WMCS(N) heater combines the economy of a storage heater with the convenience of a convector heater. The storage heater takes in energy, when electricity tariffs are low and dissipates it when tariffs are normal. The convector heater provides an instant boost on demand from normal tariff electricity.

SAFETY INSTRUCTIONS

1. Ventilate rooms well during commissioning.
2. Do not move the heater in any way once installed without the services of a competent electrician.
3. Do not cover the heater with clothing etc. at any time or position furniture close to or against the heater.
4. Ensure a clearance of at least 150mm between heaters and curtains.
5. Should your heater fail to operate either employ the services of a competent electrician or Telephone 0845 600 5111.

ALSO REFER TO COVER PAGE

COMMISSIONING

Set both the Input Control and the Output Control to 6 and leave the heater for 48 hours.

Following the commissioning period adjust the controls as stated below.

SETTING THE CONTROLS

The controls are located under the hinged flap at the top right hand corner of the heater.

To adjust the controls on the heater, use a coin and engage it in the slots provided on the top surface of the knob.

CONTROL FUNCTIONS

THE INPUT CONTROL

This heater is fitted with a user adjustable automatic input control which varies the charge taken in response to weather conditions taking into account the amount of energy already stored in the heater.

Set at 6 the heater takes maximum charge and at 1 the heater takes a minimum charge at any room temperature. The casing of the heater, particularly in late evening, may feel cool, this is quite normal. The input control may require a few days experimentation before your comfort level is established.

Initially set the control to 3, the following evening if the room is too warm reduce to 2 or if it is too cool increase to 4. On subsequent evenings adjust by half divisions until your comfort level is achieved.

Having established the setting the input will automatically vary the amount of heat stored to compensate for weather variations.

THE OUTPUT CONTROL

Most of the stored heat is radiated from the casing during the discharge period. However, some of the heat is emitted through the grille at the top of the heater and this additional heat (boost) is regulated by the Output Control.

With this set to 6 the boost begins in the early afternoon. Turning the control towards 1 will progressively delay the commencement of the boost. At 3 the boost will start in the evening. Once set, the boost will repeat itself automatically day after day.

If no boost is required, e.g. when the room will be unoccupied for along period, set the Output Control to 1. With the control in this position, the heater will take in less energy during the next charging up period.

CONVECTOR HEATER

CONVECTOR HEATER CONTROLS

The convector is selected by an on/off rocker switch which illuminates when switched on '1'. With the switch on, the convector element shall be cycled on and off by the room thermostat. With the switch off "0" the convector will not run. The room thermostat knob is marked 1 to 5. The higher the setting number chosen, the higher the level at which the room temperature will be controlled.

Your comfort level can easily be established by gradually adjusting the thermostat until the required room temperature is maintained.

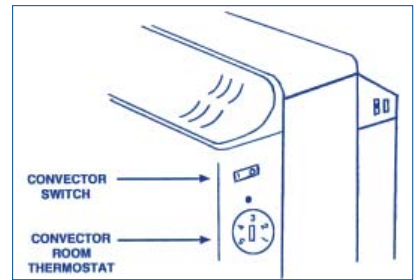

CLEANING

To maintain the appearance of the heater wipe occasionally with a dry cloth when the heater is cool.

Do not use abrasive powders or furniture polish.

Discoloration of wall finishes can sometimes occur immediately above a storage heater due to the properties of some paints and decorating materials or the presence of environmental impurities in the air (such as soot or incense generated for the burning of candles, etc.).

AFTER SALES SERVICE

Your storage heater is guaranteed for two years from date of purchase. We undertake to repair or exchange within the period, any part found to be defective due to a manufacturing fault. This guarantee does not affect your statutory rights.

Should you require after sales service, please contact the supplier through whom you purchased the heater, or telephone 0845 600 5111.

Please do not initially return faulty appliance, or part of an appliance to us as this may result in transit damage and/or a delay in providing service.

Let us know your difficulty quoting the model number and serial number (located along the wall bracket). We will then take the appropriate action.

RECYCLING



For electrical products sold within the European Community. At the end of the electrical products useful life it should not be disposed of with household waste.

Please recycle where facilities exist. Check with your Local Authority or retailer for recycling advice in your country.



Customer Help Line
Fax
Web-site

0845 600 5111
01489 773 053

www.unidareenvironmental.co.uk



This product complies with the European Safety Standards EN60335-2-30 and the European Standard Electromagnetic Compatibility (EMC) EN55014, EN60555-2 and EN60555-3. These cover the essential requirements of EEC Directives 2006/95/EC and 2004/108/EC

© GDC Group Ltd. All rights reserved. Material contained in this publication may not be reproduced in whole or in part, without prior permission in writing.
A division of the GDC Group Ltd, Millbrook House, Grange Drive, Hedge End, Southampton SO30 2DF

Part No. 87772

Issue 3 : August 2009