

Dimplex

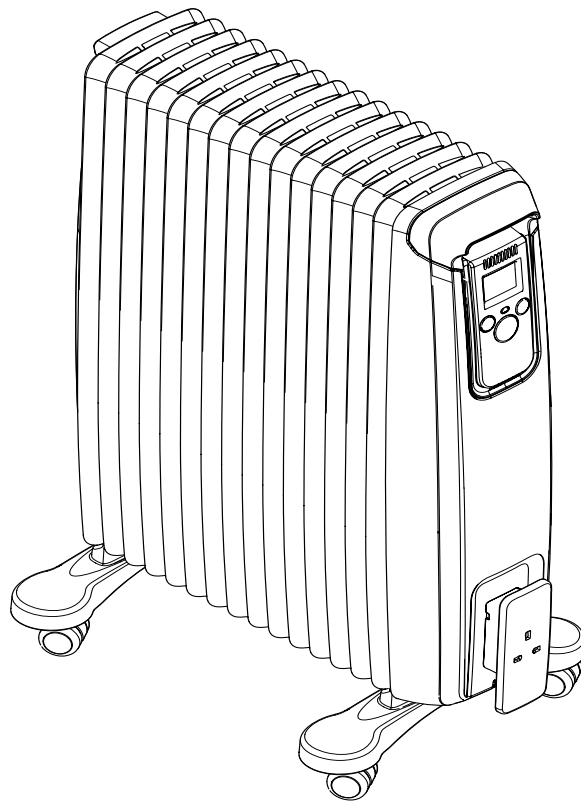

EvoRad2E

EVO | RAD

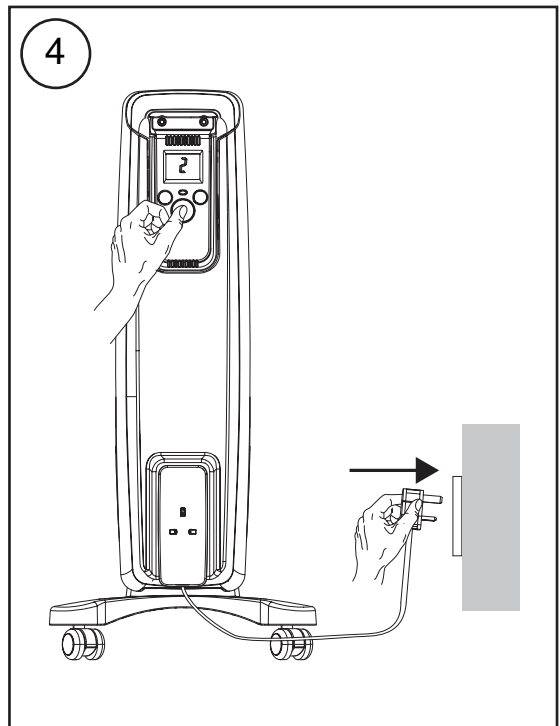
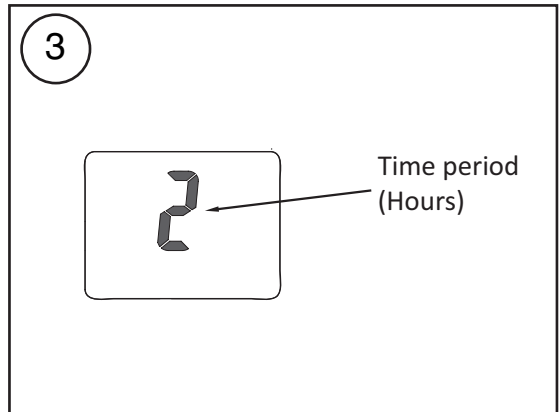
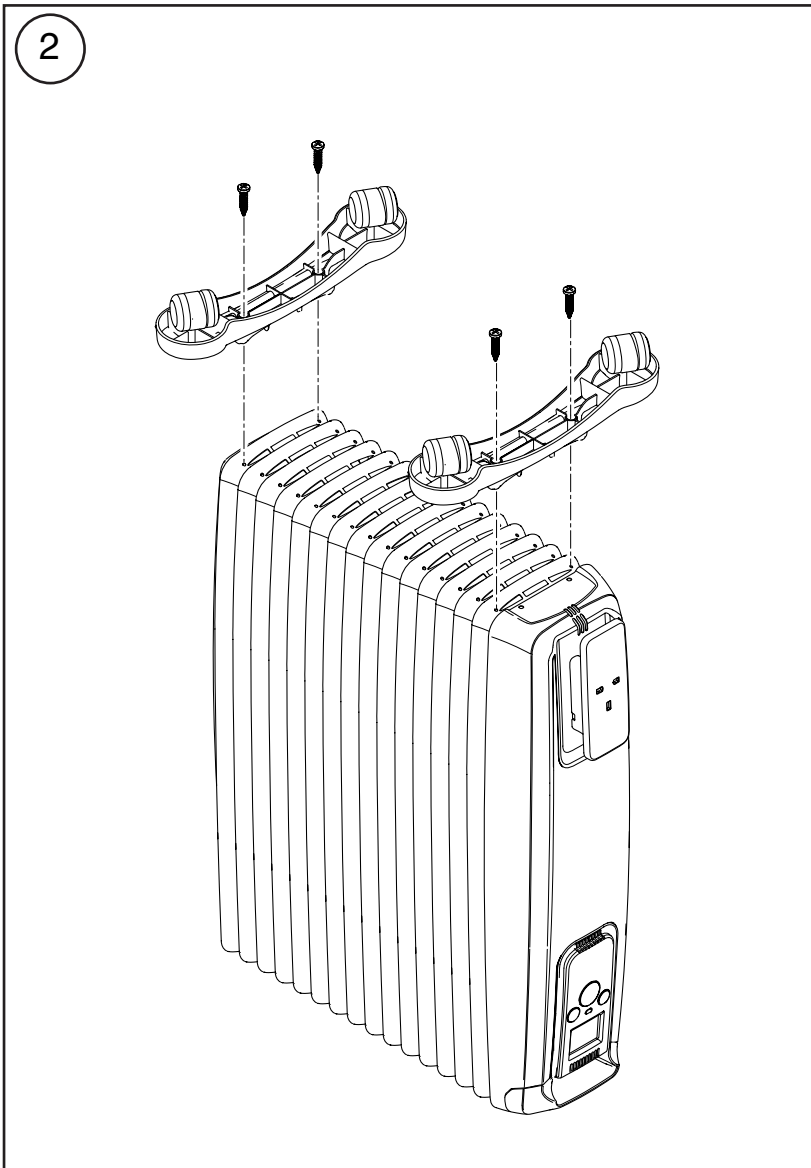
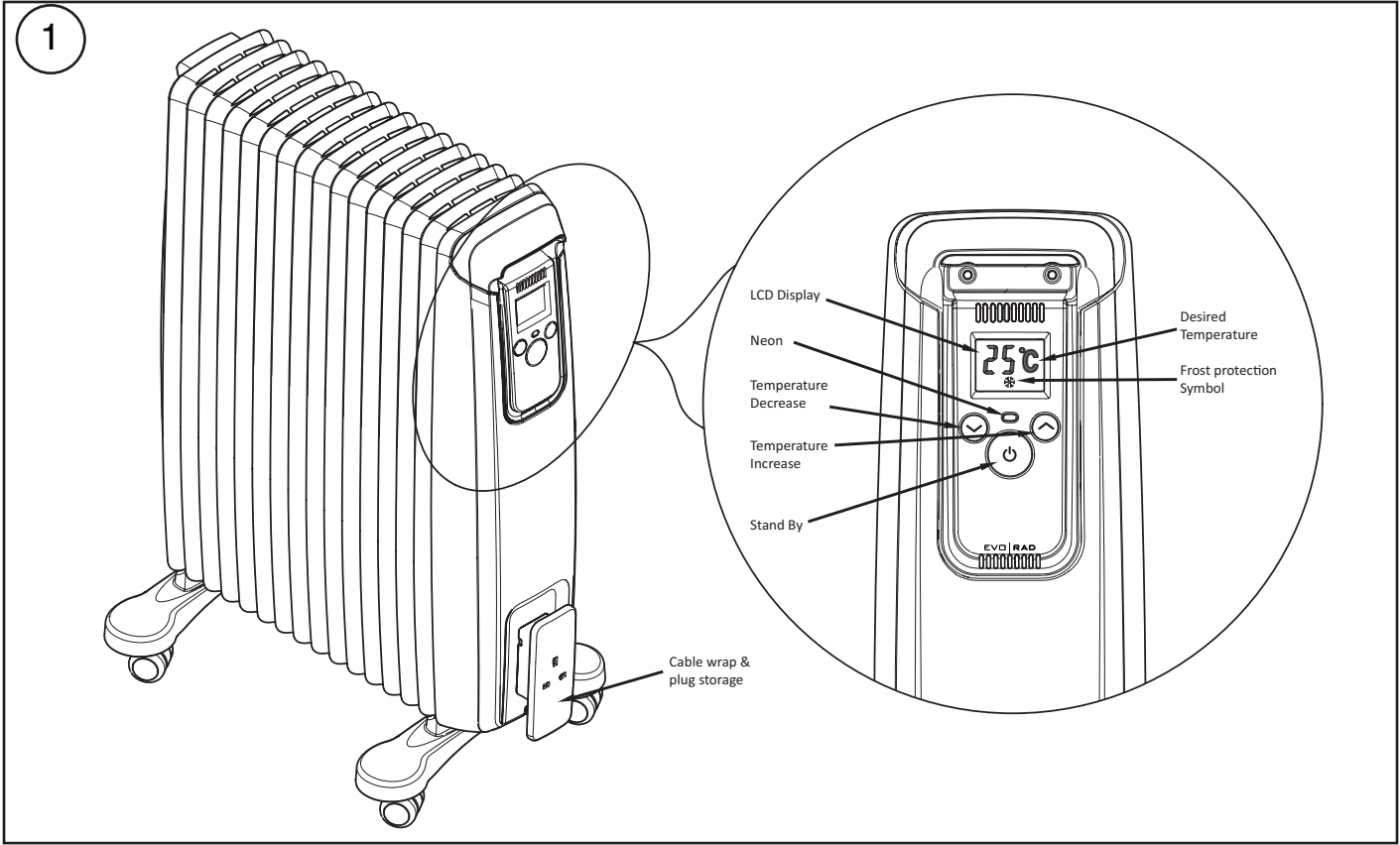

Dimplex EVO | RAD

Model : EvoRad2E

THESE INSTRUCTIONS SHOULD BE READ CAREFULLY AND RETAINED FOR FUTURE REFERENCE

Model	Description	Watts
EvoRad2E	2kW Oil free radiator with Electronic Thermostat	2000

Important Safety Advice

IMPORTANT: If the appliance is damaged, check immediately with the supplier before installation and operation.

This appliance can be used by children aged from 8 years and above and persons with reduced physical, sensory or mental capabilities or lack of experience or knowledge if they have been given supervision or instruction concerning the use of the appliance in a safe way and understand the hazards involved. Children shall not play with the appliance. Cleaning and user maintenance shall not be made by children without supervision.

Children of less than 3 years should be kept away unless continuously supervised. Children aged from 3 years and less than 8 years shall only switch on/off the appliance provided that it has been placed or installed in its intended normal operating position and they have been given supervision or instruction concerning the use of the appliance in a safe way and understand the hazards involved. Children aged from 3 years and less than 8 years shall not plug in, regulate and clean the appliance or perform user maintenance.

CAUTION: Some parts of this product can become very hot and cause burns. Particular attention has to be given where children and vulnerable people are present.



This heater carries the warning symbol indicating that it must not be covered.

DO NOT use the heater in the immediate surroundings of a bath, a shower or a swimming pool.

WARNING: This heater must not be used in a bathroom.

DO NOT place the heater directly below a fixed socket outlet.

WARNING: In order to avoid overheating, do not cover the heater.

We recommend that you open a window to ventilate the room when using the heater for the first time.

Unplug the heater when not required for long periods.

IMPORTANT: If the mains lead of this appliance is damaged, it must be replaced by the manufacturer or its service agent or a similarly

qualified person in order to avoid a hazard.
DO NOT use the heater where gas, petrol, paint or other inflammable goods are used or stored.

The heater is designed for operation on an AC electricity supply, and is suitable for use in domestic dwellings and similar indoor locations.

Always ensure that the appliance is stood on a firm, level base near to, but not directly beneath, a suitable fixed socket outlet.

The heater is fitted with castors and a handle for ease of movement.

It is supplied with a cord and plug ready for use.

The supply cord should be uncoiled before use (see 'Storage').

DO NOT pull the heater along by the mains lead.

Important - The heater must only be operated with the wheels and castors fitted and in the upright position as shown in **Fig. 1**.

Warning – The heater complies with stringent safety standards but to ensure efficient operation **SURFACES OF THE HEATER WILL BECOME HOT AND CONTACT WITH THESE AREAS SHOULD BE AVOIDED**, particularly between the fins on the top and sides.

Electrical

WARNING – THIS APPLIANCE MUST BE EARTHED

If the socket outlets in your home are not of the 13 amp BS1363 type they will not accept the plug connected to this heater, therefore cut off the plug. When cut off this plug can constitute a shock hazard if inserted into a socket outlet. It must therefore be disposed of safely.

Before wiring the appropriate plug please note that the wires in this mains lead are coloured in accordance with the following code:

GREEN/YELLOW:	EARTH
BLUE:	NEUTRAL
BROWN:	LIVE

Connect the Green/Yellow wire to the terminal marked E or the earth symbol or coloured Green or Green/Yellow.

Connect the Brown wire to the terminal marked L or coloured Red.

Connect the Blue wire to the terminal marked N or coloured Black. **DO NOT** connect the Brown (Live) or the Blue (Neutral) wires to the Earth terminal of your 13 amp plug. If the terminals of the plug are unmarked or you are in any doubt, consult a qualified electrician.

Fitting the castors

IMPORTANT: The castors should only be fitted to the outer fins (as shown in **Fig. 2**). Fitting the castors to any other fin may result in the product becoming unstable and may topple over during operation.

WARNING: THE HEATER IS HEAVY – TAKE CARE WHEN LIFTING AND ENSURE THAT IT IS SUPPORTED DURING ASSEMBLY TO PREVENT IT FROM TOPPLING.

Remove the carton containing the castor assemblies from the packing.

Turn the heater upside down on a carpet or other soft surface to avoid damage. If required request the assistance of a second person. Position a castor bracket onto the outer fin and secure in place using the screws provided (see **Fig. 2**). Repeat the process for the other castor, ensuring it is located on the other end fin.

Lift the heater clear of the floor, then turn it back upright and stand it on its castors as shown in **Fig. 1**. It is now ready for use.



Positioning the Heater

Select the position for the heater ensuring there is clearance from any furniture and fittings of at least 300mm above the heater and 150mm each side. The heater should only be operated on a flat stable surface.

Operating the Heater - 'Control Mode'

With the product plugged in, press the  button. This will illuminate the neon and also light up the LCD display. This indicates that the product is in control mode, the desired room temperature can then be set.

Setting the 'Desired' Room Temperature



The temperature is set using the temperature increase  and temperature decrease  keys - see **Fig. 2**. The room temperature can be set in the range between 5°C to 30°C. The back light of the LCD will change colour depending on the desired room temperature. (Blue screen 5 to 16, 17 to 19 green, 20 to 22 white, 23- 30 red). Please note the temperature setting is for desired room temperature (not the actual room temperature).

'Intelligent' Eco Mode

This is the appliance default setting, the appliance will automatically start up in this setting once power is applied and the standby key is pressed. The LCD display will indicate the desired room temperature and the appliance will automatically regulate the room temperature accordingly. In this mode the appliance operates at full power, however the output of the appliance is automatically reduced and regulated as the room temperature approaches

the desired level. This mode optimises energy use by calculating the most efficient and effective way to achieve the desired temperature setting. The desired room temperature can be adjusted at any time during operation by pressing the appropriate key.

Standby Mode

With the heater ON if the  button is pressed, the heater will go into standby mode, the heater switches off and the display will go blank. On pressing the  button again the heater will come on in the with the desired room temperature settings it had prior to going into standby mode.

Note: the mains on 'Neon' will remain illuminated when the appliance is in standby mode.

LCD Display

The LCD display shows the desired room temperature. When the appliance is set to frost protection mode (5°C) the frost protection symbol  will be displayed on the screen.

The colour of the display backlight will vary depending on the desired temperature set (see notes above under 'Setting the desired room temperature'). The backlight will switch off a short period after the last key press. Any additional key presses will re-illuminate the screen.

Indicator Neon



The control contains an indicator neon. This neon comes on to indicate when the product is in 'control mode'. This neon does not indicate if the heat is on, if the room temperature is at the desired temperature then the heat will be off but the control is still operating, the neon will remain on.

When the delayed start function is activated the neon will blink intermittently to indicate the product is in delayed start mode. Once the delayed start period has elapsed the neon will switch on to indicate the product is in control mode.



Frost Protection Mode

The appliance has a frost protection mode. This setting is useful in areas such as garages to assist in the prevention of frost damage. If the thermostat is set to its minimum setting '5°C', the heater will cycle ON and OFF to maintain a temperature of approximately 5°C and help protect against frost conditions. The frost protection symbol  will be displayed on the LCD display when frost protection mode is activated.



Runback Timer Mode

When the appliance is in Control mode and the  and  buttons are simultaneously pressed for more than 2 seconds the appliance shall enter a 'Runback' configuration menu.

The 'Runback' mode will allow the appliance to run, from now, for a pre-set time. After this time has expired the appliance shall enter Standby mode and the Runback timer shall clear to zero (no subsequent Runback). Keeping the buttons pressed the display will indicate the number of hours the Run Back time shall be enabled, from 1 through to 12. Fig. 6 below shows an example of a two hour Runback. After 12 the timer shall roll over to 1 and then increment through to 12 again. The time shall increment for every 2 seconds that the buttons are simultaneously pressed. When one or both buttons are released it shall be assumed that the Run Back time has been selected. Both buttons must be released before any other button operations are allowed. The Run Back function shall not be maintained if mains power is removed and reapplied.

The Runback function shall use the maximum power as defined using the  button sequence and the Set Point active prior to entering Run Back mode. The temperature Set Point may be changed by pressing the  or  buttons while in Run Back Mode. The display shall flash On and Off every 5 seconds showing the hours remaining in Runback mode, until the Runback time has expired, then the display shall be turned off (appliance enters Standby Mode). Please note only hours will be displayed not part of hours i.e. minutes

Delayed Start Mode

When the appliance is in Control mode and the  and  buttons are simultaneously pressed for more than 2 seconds the appliance shall enter a 'Delayed Start' configuration menu.

The 'Delayed Start' mode will allow the appliance to turn ON after a pre-set time. After this time has expired the appliance will turn ON and control about the set point. The appliance shall stay ON until the mains power is toggled or the  button is pressed to place the unit in Standby.

Keeping the buttons pressed the display will indicate the number of hours the Start Timer shall delay the appliance entering operation, from 1 through to 12. After 12 the timer shall roll over to 1 and then increment through to 12 again. The time shall increment for every 2 seconds that the buttons are simultaneously pressed. When one or both buttons are released it shall be assumed that the Delayed Start time has been selected. Both buttons must be released before any other button operations are allowed.



To indicate that the Delayed Start Timer function has been enabled the Neon shall blink intermittently once every 10 seconds.

The Delayed Start time shall be cleared to zero when the  button is pressed, the Delayed Start timer expires or if mains power is removed. The LCD display will display the Hours remaining in Delayed Start mode (No Backlight) and displays hours only increments (not minutes). Once the delayed start time has expired the appliance enters control mode, and the display will now show the Set Point.

The Delayed Start function shall not be maintained if mains power is removed and reapplied. The Delayed Start function shall use the maximum power as defined using the  button sequence and the Set Point active prior to entering Delayed Start mode.

Power Select Mode

It is possible to alter the power output of the appliance. Doing this limits the power output of the appliance, there are two alternative power modes available, mid heat (1200W) and low heat (800W). To change the power mode setting it is necessary to do the following:

1. The product must be first switched off and then switched on, this can be done by plugging in the appliance - see **Fig. 4** or by switching it on at an isolator switch. At the same time press and hold the  key for at least 2 seconds after main power is applied.
2. After power up '2' will appear on the LCD display and the standby key can be released. '2' indicates that the appliance is in mid heat mode.
3. In order to select low level heat setting press the  key within 5 seconds. The Display on the LCD should change to '1'.
4. Once the desired heat setting is reached do not press any other keys. After a short period the LCD will switch off and the appliance will revert to standby mode.
5. Pressing the  button again will turn on the display and the appliance will be in control mode. The display will toggle between the set temperature and the power mode setting, for example between 25°C and '2'
6. In order to revert to the default Eco mode, simply switch off the power at the wall or unplug the appliance. On the next operation (when plugged in) it will automatically revert to Eco mode.

Safety in use

This appliance incorporates a number of safety devices. In addition to the '**Important Safety Advice**' section your attention is drawn to the following;

Tilt Switch

The tilt switch will prevent the heater from working if it is accidentally tipped over on its side. If the radiator is tipped over while it is hot, disconnect the power and allow it to cool, then stand the radiator back upright. Reconnect the power - normal operation should be resumed.

Safety Overheat Protection

For your safety this appliance is fitted with a thermal cut-out. In the event that the product overheats for some reason, the cut-out prevents excessive temperatures on the product by cutting the power to the heater. Once the heater has cooled down, it will reset automatically, it will continue to cycle on and off automatically until the reason for overheating is removed.

Storage

If the heater is not required for long periods, for example during the summer, it should be stored in a dry place and preferably covered to prevent the accumulation of dirt and dust. The supply cord should be neatly coiled around the cable wrap and the plug stored in the cable wrap moulding.

Cleaning

WARNING - ALWAYS DISCONNECT THE POWER SUPPLY BEFORE CLEANING THE HEATER.

Do not use detergents, abrasive cleaning powder or polish of any kind on the body of the heater.

Allow the heater to cool, then wipe with a dry cloth to remove dust and a damp cloth (not wet) to clean off stains. Be careful not to allow moisture in to the heater.

Recycling



For electrical products sold within the European Community. At the end of the electrical products useful life it should not be disposed of with household waste. Please recycle where facilities exist. Check with your Local Authority or retailer for recycling advice in your country.

After Sales Service

Your product is guaranteed for 3 years from the date of purchase The 3 year guarantee is extended for an additional 2 years when you register the product with Dimplex, within 28 days of purchase. If you do not register the product with Dimplex within 28 days, your product will remain guaranteed for 3 years only.

Within the extended warranty period we undertake to repair or exchange this product free of charge providing:

- a) Proof of purchase such as a sales receipt can be provided, showing that the appliance was bought within the 36-months prior to registering the defect/fault.
- b) The appliance was correctly operated in accordance with the manufacturer's instructions and used solely for domestic purposes.
- c) The defect/fault was not as a result of accident, misuse, unauthorised modification or inexpert repair

Your rights under this guarantee are additional to your statutory rights, which in turn are not affected by this guarantee.

Validation of extended warranty

To validate your extended warranty register with us online at <http://register.dimplex.co.uk>

N.B. Each qualifying product needs to be registered with Dimplex individually.

Please note that the extended warranty is only available in the UK and Ireland